

DS 200

System pro M compact®

- DS 200 L
- DS 200
- DS 200 M
- DSB 200 M

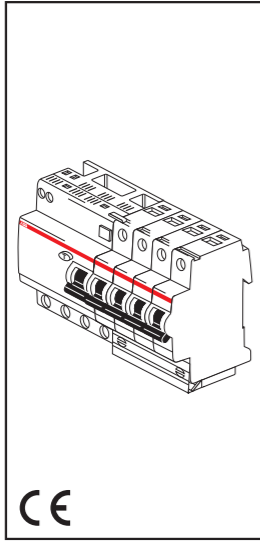

2CSR43001D0007



ABB S.p.A.
V.le dell'Industria 18
20009 Vittuone (MI), Italy

www.abb.com/lowvoltage

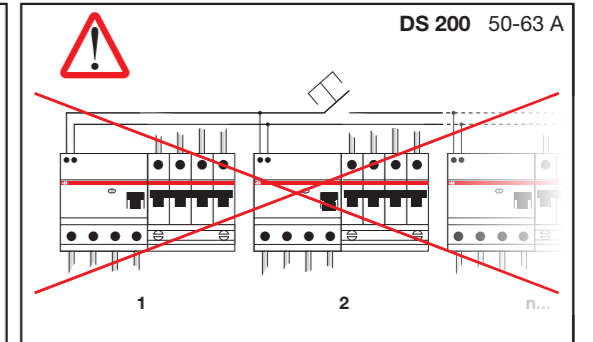
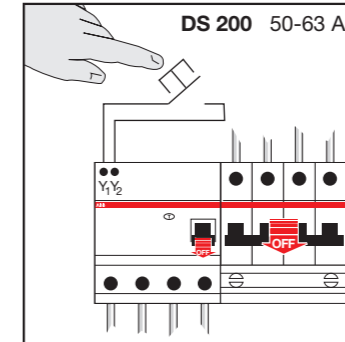
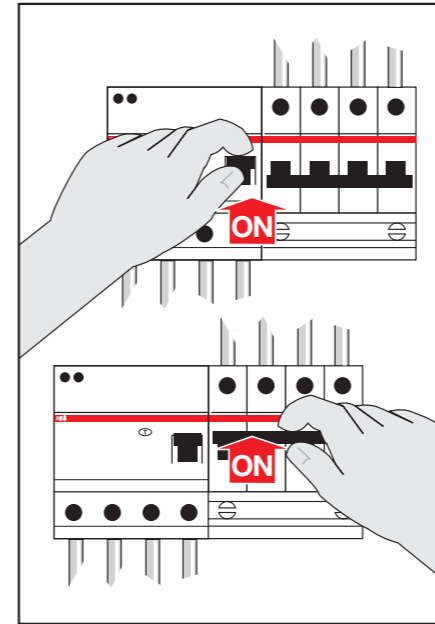
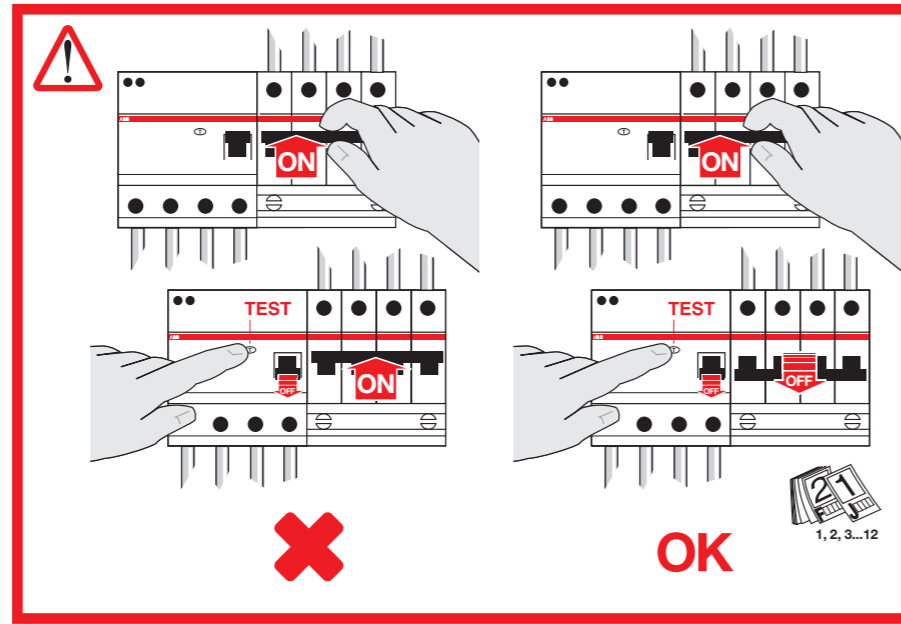
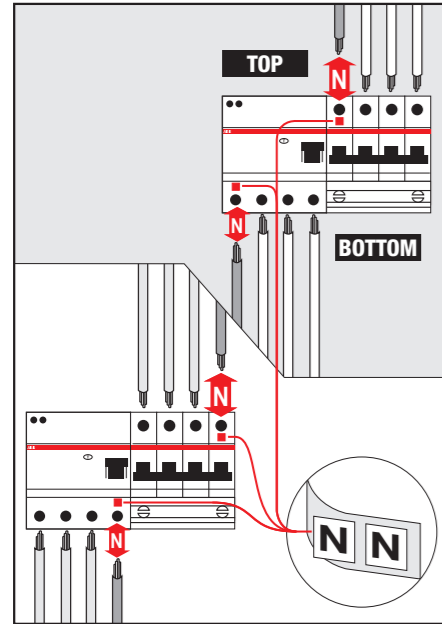
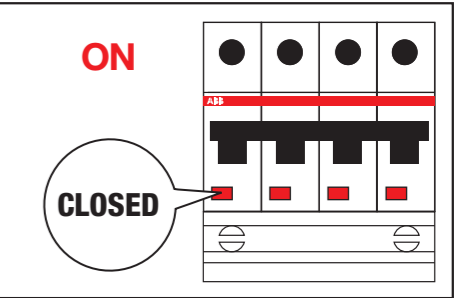
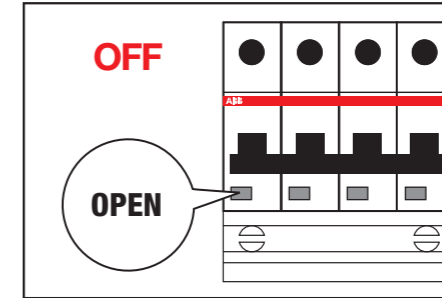
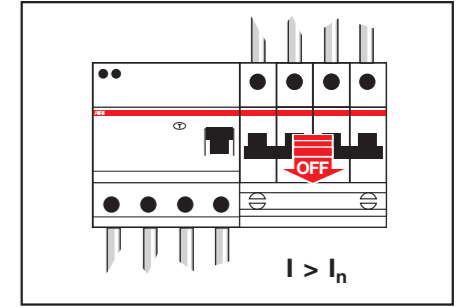
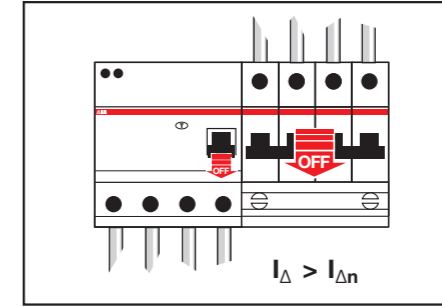
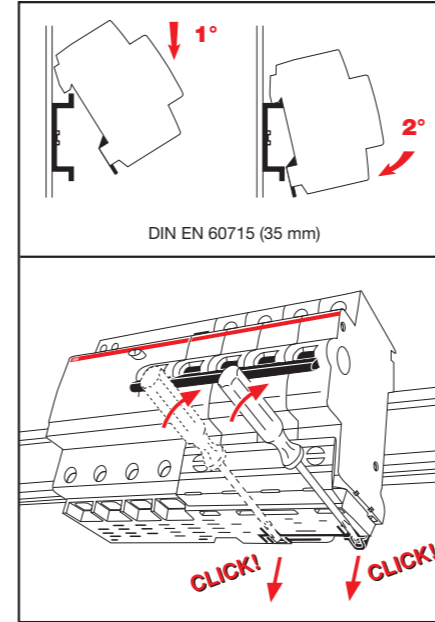
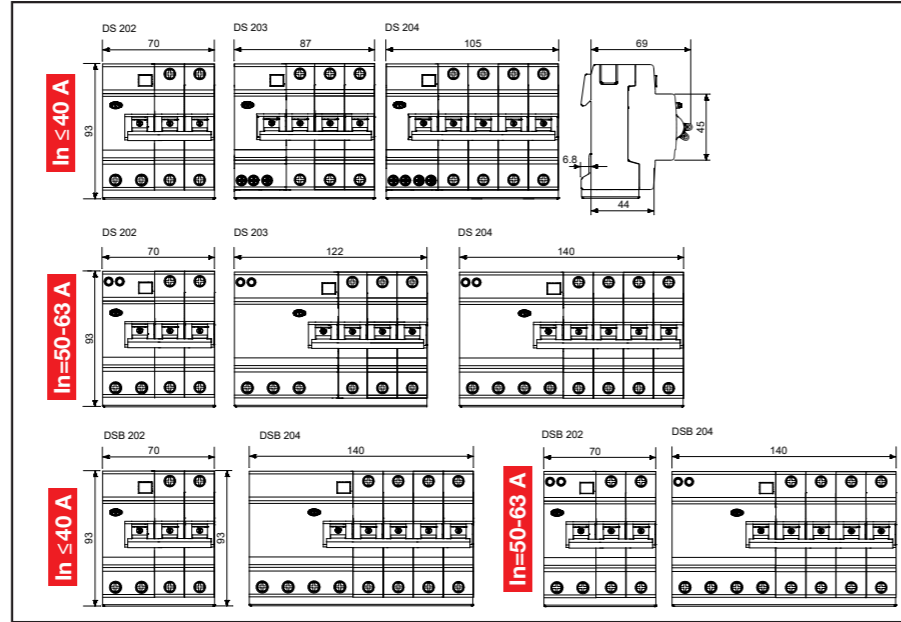

⚠	Standard terminals System pro M compact		Additional terminals for remote tripping (6 mm ²)	
2P	12,5 mm	2,8 Nm	Additional terminals not present	
3P; 4P; In ≤ 40A	12,5 mm	BOTTOM 1,2 Nm TOP 2,8 Nm	Additional terminals not present	
3P; 4P; 50A ≤ In ≤ 63A	12,5 mm	2,8 Nm	10,2 mm	0,8 Nm