











- FR:** Projecteur Trust V2
- EN:** Floodlight Trust V2
- DE:** Flutlicht Trust V2
- IT:** Proiettore Trust V2
- ES:** Proyector Trust V2
- PL:** Iluminacja Trust V2



| | |
|--|---|
|  | 30000h |
| SMD3030 |  120° |
|  4000K | CRI > 80 |
|  IP66 |  |
| 230V |  |
| Aluminum | CE |

| | |
|--|--|
| | |
|--|--|

| | | | | | |
|---|---|---|---|------------|---|
|  |  |  |  | CRI |  |
| 3297027400471 | 150W | 22500lm | 4000K | > 80 | 31.2x30.9x5.3 cm |

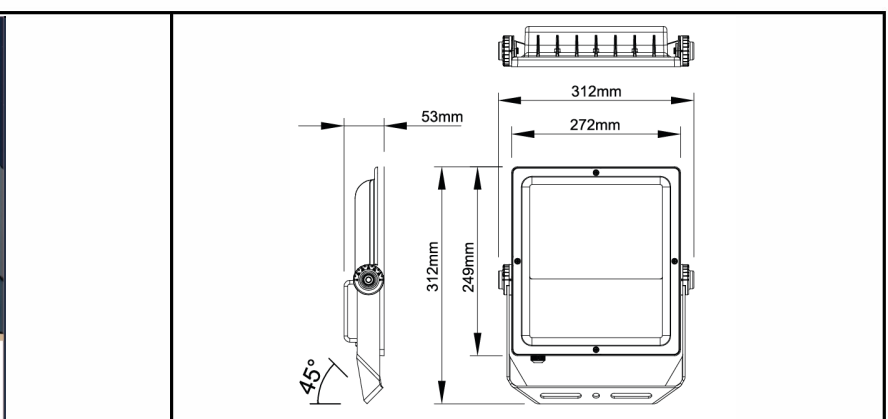

ARLUX

Traverse de la Bastidonne – 13400 Aubagne.
 Tel: +33 (0)4 91 02 50 90 | Fax: +33 (0)4 91 93 74 59 | svcom@arlux-lighting.fr
 SAS au Capital de 800 000 euros | RCS Marseille 489 327 148