

QUICK START GUIDE

1] PRODUCT PRESENTATION

Feature	Description
Material	ABS, PC (lid)
Power Supply	12-24Vdc (+/- 10%)
Consumption (+/- 10%)	<ul style="list-style-type: none"> 20mA (Standby) 40mA (Alarm)
Outputs	3 x NO/NC/COM
Dual color LEDs	Green: Standby Red: Alarm
Dimensions	90 (L) x 93 (W) x 45 (D) mm
Weight	0.7 kg

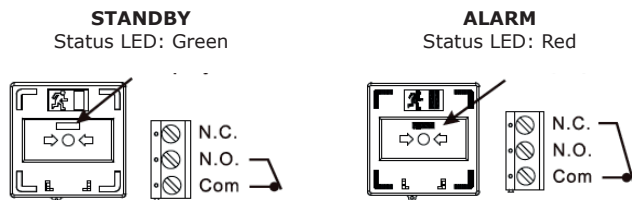

2] PACKAGE CONTENTS

Unit	Key	PA4	Screws
1	1	4	4

3] INSTALLATION

ATTENTION

Press down on the transparent plastic membrane to ensure that the LED changes from green to red.

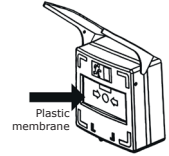

1 Unclip the front panel A from the base C.

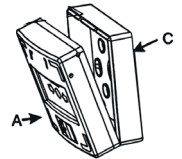

2 Fix the base C and connect the wires to the circuit board. Make the settings (buzzer, LEDs, number of contacts).

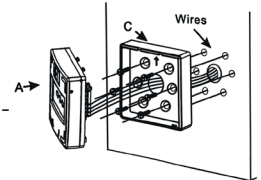

3 Clip the front panel A back onto the base C, then insert the screw supplied into the underside of the BBG.

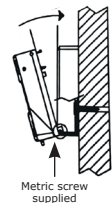

4 Insert the key fully and remove it when the red light turns green to complete the installation.

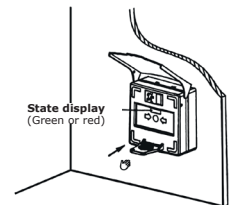

4] CÂBLAGE ET CONNECTIONS

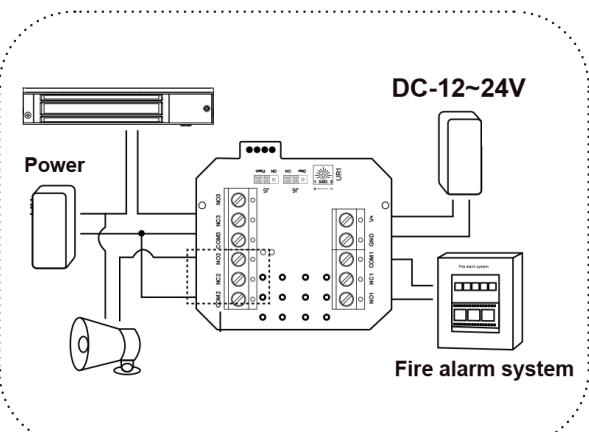
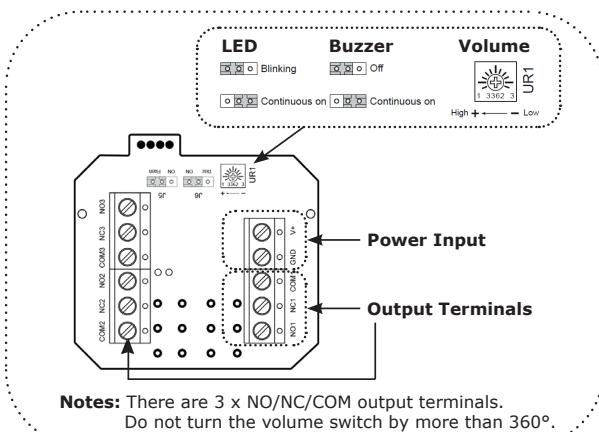

1] PRÉSENTATION PRODUIT

Spécificités	Description
Matériau	ABS, PC (couverture)
Alimentation	12-24V DC (+/- 10%)
Consommation (+/- 10%)	<ul style="list-style-type: none"> • 20mA (En veille) • 40mA (En mode alarme)
Relais	3 x NO/NC/COM
LEDs bicolores	Vert : En veille Rouge : En mode alarme
Dimensions	90 (L) x 93 (l) x 45 (P) mm
Poids	0,7 kg

STANDBY
Statut LED : Vert

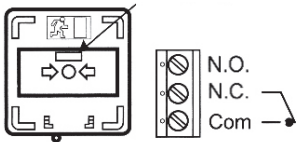

EN MODE ALARME
Statut LED : Rouge

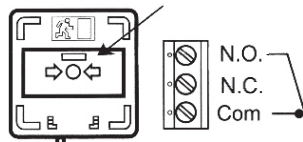

CE Certification CE

DEEE & RoHS

UKCA Certification UKCA

2] ÉLÉMENTS CONTENUS

Unité	Clé	PA4	Vis
1	1	4	4

4] CÂBLAGE ET CONNECTIONS

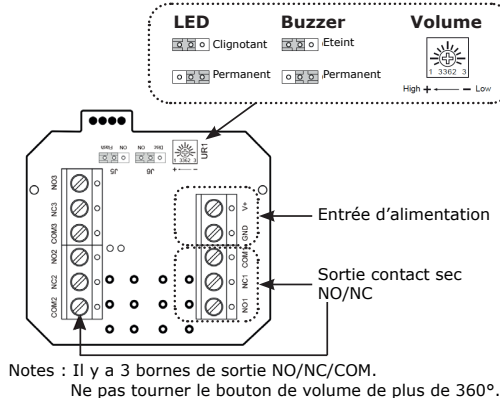

3] INSTALLATION EN APPLIQUE

ATTENTION
Appuyer sur la membrane plastique transparente pour s'assurer que le voyant passe du vert au rouge.

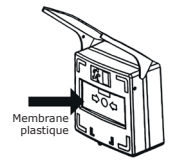

1 Déclipser la face avant A du fond C.

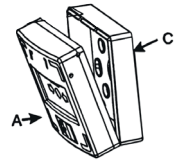

2 Fixer le fond C et connecter les câbles sur la carte électronique. Procéder aux réglages (buzzer, LEDs, nombre de contacts).

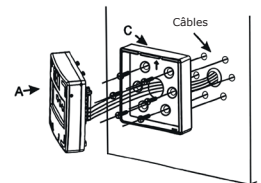

3 Reclipser la face avant A sur le fond C puis insérer la vis fournie en dessous du BBG.

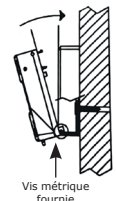

4 Insérer la clé à fond puis la retirer lorsque le voyant rouge passe au vert pour terminer l'installation.

