









 35°C			 	 Ø 26 Ø 38		 			
240 V~	1000 W	1000 W	500 VA	500 VA	500 VA	500 VA	100 VA	1000 W	I max. ≤ 2A
100 V~	500 W	500 W	250 VA	250 VA	250 VA	250 VA	50 VA	500 W	I max. < 1A



- Toutes les bornes de chaque produit doivent être câblées avant la mise sous tension.
- Alle klemmen van elk product moeten worden bekabeld, voordat het onder spanning gezet wordt.
- All terminals on every device must be wired before powering up.
- Alle Klemmen aller Geräte müssen vor der Inbetriebnahme verdrahtet sein.
- Todas las bornas de cada producto deben cablearse antes del encendido.
- Güç verilmeden önce her bir cihazdaki tüm terminalerin kablo bağlantısı yapılmış olmalıdır.
- Todos os terminais de cada produto devem estar ligados antes de colocar sob tensão.
- Όλοι οι πόλοι κάθε προϊόντος πρέπει να καλωδιωθούν πριν να τεθούν υπό τάση.
- Подсоединить кабели к зажимам каждого устройства до подачи питания.

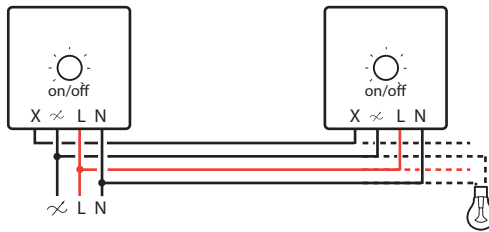
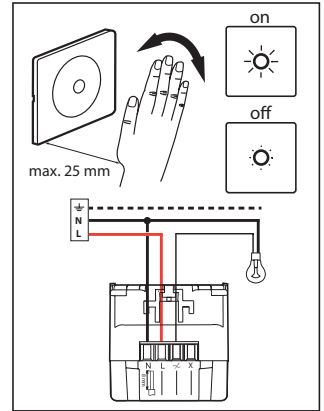
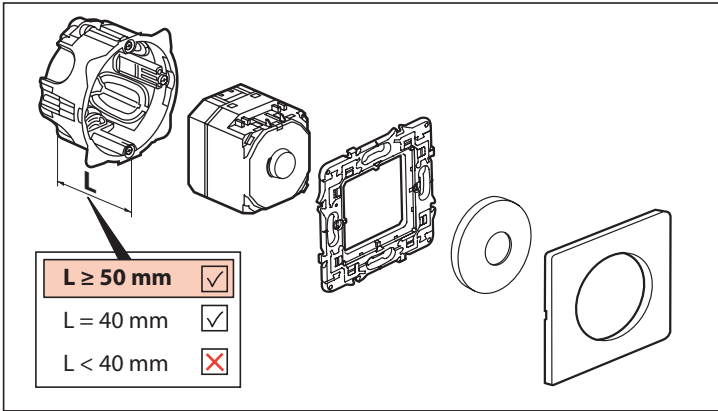