

- Contact auxiliaire de précoupure
 - Hulpcontact voor vooronderbreking
 - Pre-breaking auxiliary contact
 - Vortrennungs-Hilfskontakt
 - Contacto auxiliar de precorte
 - Contatto ausiliario di preapertura
- 222 25/26/27

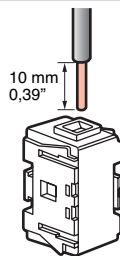

222 25/26/27

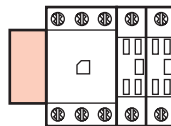
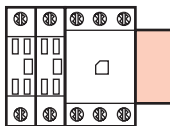
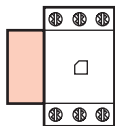
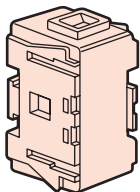

- Assemblage
- Assemblage

- Encastré
- inbouw
- Flush-mounting
- Unterputz
- De empotrar
- Ad incasso

- Assembly
- Zusammenbau

- Ensamblaje
- Assemblaggio

- Saillie
- opbouw
- Surface-mounting
- Aufputz
- De superficie
- Sporgente

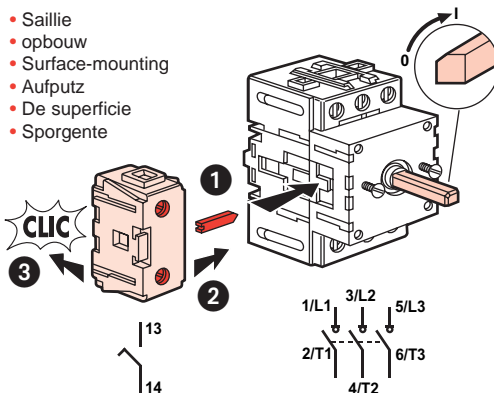
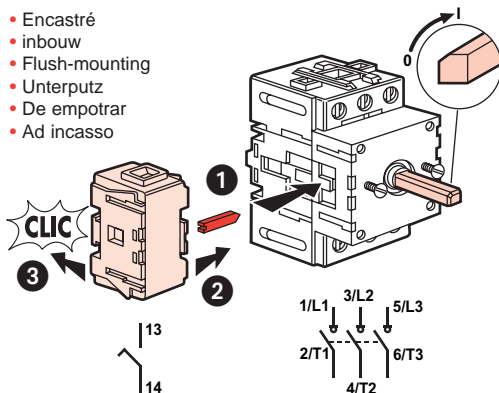

! 222 25 (25/32A)

< 3 mm
< 0,12"

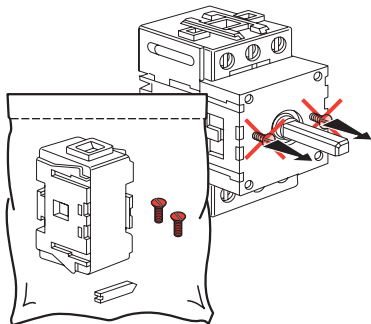

3 - 6 mm
0,12 - 0,24"

