

Plexo Junction boxes

Cat. No(s): 0 920 01/02/03/05/11/12/13/14/20/22/23/24

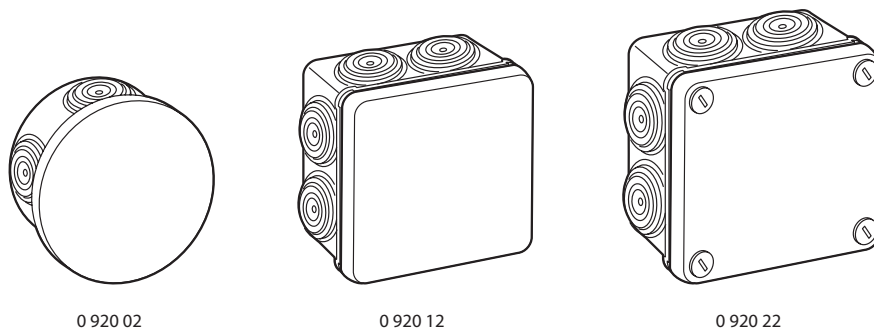

0 920 02

0 920 12

0 920 22

CONTENTS

Pages

1. General characteristics	1
2. Material characteristics	1
3. Technical characteristics	1-2
4. Accessories	2
5. Dimensions	2
6. Resistance to chemical agents	3

1. GENERAL CHARACTERISTICS

Weatherproof round and square boxes with interchangeable membrane glands, with smooth faces or pre-cut knock-outs.
Clip-on or screw-on (¼ turn fixing) cover.
Can be used as a junction box in normal installation circuits (domestic, industrial and public buildings in accordance with French law, Article EL 10).

Cat. No.	Internal dimensions	Number of glands	Type of cover	RAL colour
0 920 01	Ø 60	4	Clip-on	Grey RAL 7035
0 920 02	Ø 70	4	Clip-on	Grey RAL 7035
0 920 03	Ø 70	4	Clip-on	White RAL 9010
0 920 05	65 x 65 x 40	7	Clip-on	Grey RAL 7035
0 920 11	80 x 80 x 45	Smooth	Clip-on	Grey RAL 7035
0 920 12	80 x 80 x 45	7	Clip-on	Grey RAL 7035
0 920 13	80 x 80 x 45	7	Clip-on	White RAL 9010
0 920 14	80 x 80 x 45	7 ⁽¹⁾	Clip-on	Grey RAL 7035
0 920 20	105 x 105 x 55	Smooth	Screw-on	Grey RAL 7035
0 920 22	105 x 105 x 55	7	Screw-on	Grey RAL 7035
0 920 23	105 x 105 x 55	7	Screw-on	White RAL 9010
0 920 24	105 x 105 x 55	7 ⁽¹⁾	Screw-on	Grey RAL 7035

⁽¹⁾Pre-cut knock-outs

2. MATERIAL CHARACTERISTICS

Boxes: ABS
Cover: Polypropylene
Cover fixing screws: polyamide
Glands: elastomer
These materials do not contain any halogen.

3. TECHNICAL CHARACTERISTICS

- Protection index: IP 55 - IK 07
- Resistance to incandescent wire 650°C in accordance with EN 60695-2-1
- Good resistance to UV, salt spray, oil and grease
- Class II ensured by protective caps (supplied) for the fixing screws
- Interchangeable membrane glands
- Operating temperature: - 25°C to + 45°C
- Diameter of cables and tubes accepted:
 - 4 to 20 mm for round and square boxes up to 80 x 80
 - 4 to 25 mm for 105 x 105 square boxes
- Fixing with vertical level adjustment possible using Ø 5 mm max. screw
- Possible to fix outside the wiring space using Ø 4 mm screws for square boxes Cat. Nos. 0 920 20/22/23/24
- Can be fixed using wall plug Cat. No. 0 319 57
- Can be fixed using SPIT "Pulsa 700 E" nail gun
- Removable cover linked with the box by a tie

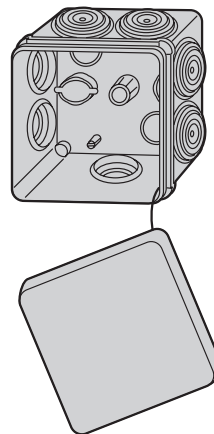

- Marking areas on the cover for labelling the circuits on internal face and identifying the junction on external face.

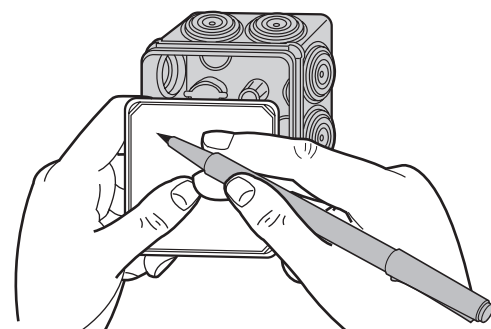

Plexo

Junction boxes

Cat. No(s): 0 920 01/02/03/05/11/12/13/14/20/22/23/24

3. TECHNICAL CHARACTERISTICS (continued)

- Installing cables and tubes \varnothing 16 mm

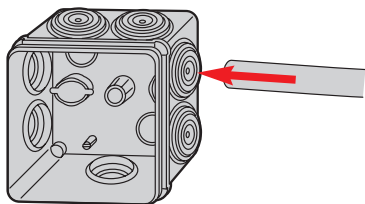

- Installing \varnothing 20 and 25 mm tubes

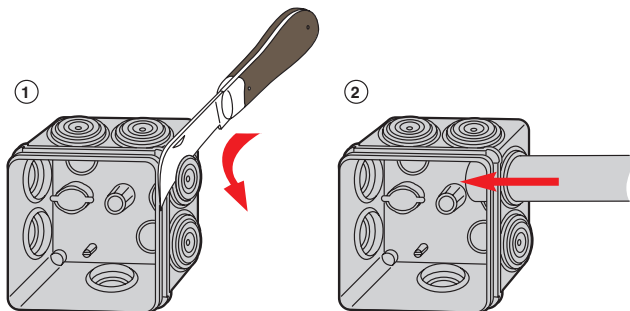

_ Specific installation in case of condensate drain:
Creation of drainage holes with a diameter of 6mm at the places indicated according to the direction of assembly.

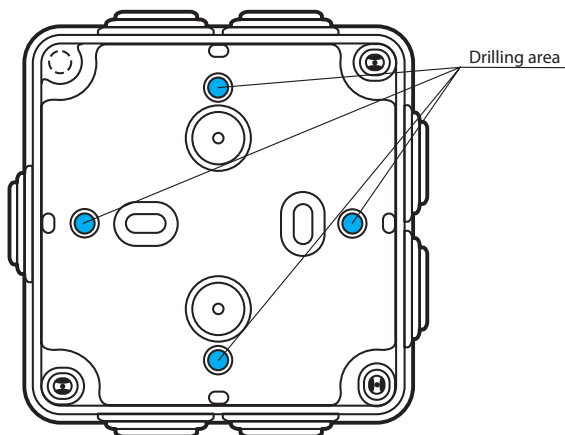
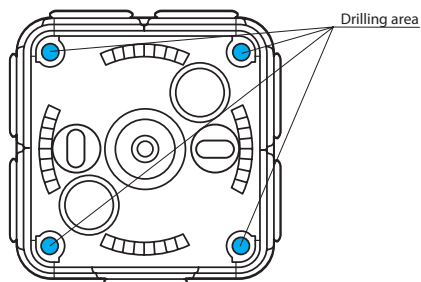
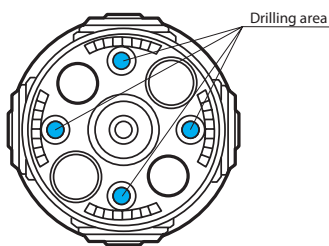

4. DIMENSIONS (mm)

- Round box \varnothing 60 Cat. No. 0 920 01

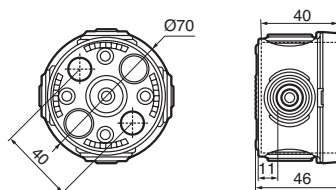

- Round box \varnothing 70 Cat. No. 0 920 02/03

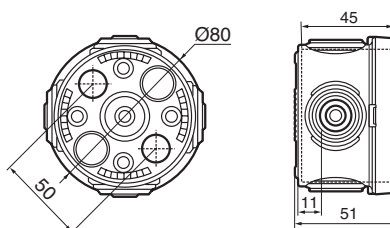

- Square box 65 x 65 Cat. No. 0 920 05

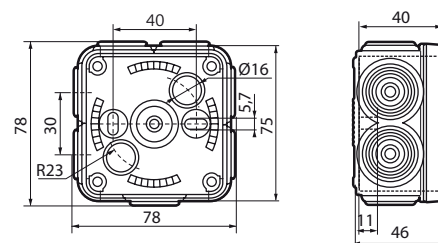

- Square box 80 x 80 Cat. No. 0 920 11/12/13/14

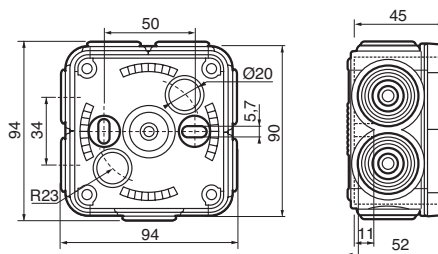

- Square box 105 x 105 Cat. No. 0 920 20/22/23/24

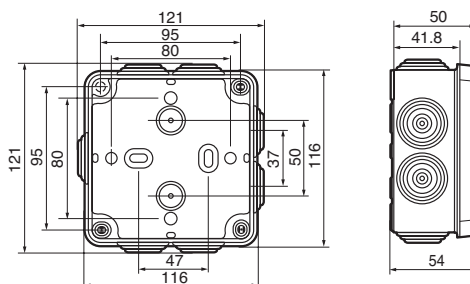

Plexo

Junction boxes

Cat. No.(s): 0 920 01/02/03/05/11/12/13/14/20/22/23/24

5. ACCESSORIES

- Indelible black felt tip pen Cat. No. 0 395 98 for marking
- Spare membrane glands

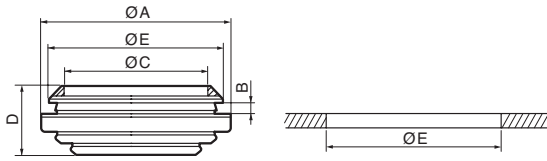

	A	B	C	D	E
Ø 20	Ø 27.6	2	Ø 20	9.5	Ø 22
Ø 25	Ø 33.8	2	Ø 25	12	Ø 27.5

Selection chart for spare membrane glands

Box (in mm)	Glands	
	Grey RAL 7035	White RAL 9010
Ø 60	0 919 14	-
Ø 70	0 919 14	0 919 08
65 x 65	0 919 14	-
80 x 80	0 919 14	0 919 08
105 x 105	0 919 15	0 919 00

- Mounting plate for wire cable trays: Cablofil wire KZ and F31, Cat. No. 0 919 37 for 80 x 80 boxes, Cat. No. 0 919 38 for 105 x 105 boxes.

- Junction strip
Cat. No. 0 312 10 with 4 mm² terminals for 80 x 80 boxes

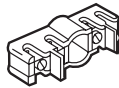

6. RESISTANCE TO CHEMICAL AGENTS

- Round box Ø 60 Cat. No. 0 920 01

	Polypropylene	ABS	SBS (glands)
Acetone	+ (100%)	+	
Acetic acid	+ (50%)	+ (10%)	+ (10%)
Hydrochloric acid	+ (36%)	+ (10%)	+ (10%)
Citric acid (10%)	+	+	+
Hydrofluoric acid (4%)	+	+	+
Lactic acid	+ (90%)	+ (10%)	+ (90%)
Nitric acid (10%)	+	+	+
Phosphoric acid (85%)	+	+	(+)
Sulphuric acid (25%)	+	+	+
Tannic acid			
Ethyl alcohol	+	(+)	+
Methyl alcohol	+	(+)	+
Ammonia	+	+	+
Barium chloride	+	+	+
Benzene	(+)		(+)
Lime	+		
Seawater	+	+	+
Oil, grease	+	+	+
Milk	+	+	+
Fuel oil			
Petroleum, petrol	+	(+)	+
Sodium chloride (20%)	+	+	+
Caustic soda (40%)	+	+	+
Sugars			
Toluene	(+)	-	-
Trichloroethylene	-	-	-
Urine			
Wine	+	+	+
Liquid chlorine	(+)		
Aniline	+	-	+
Bleach	(+)	+	(+)

+ resistant, (+) limited resistance, - unstable

These indications are given for information purposes only
They imply no commitment on our part.