

2a / 3a

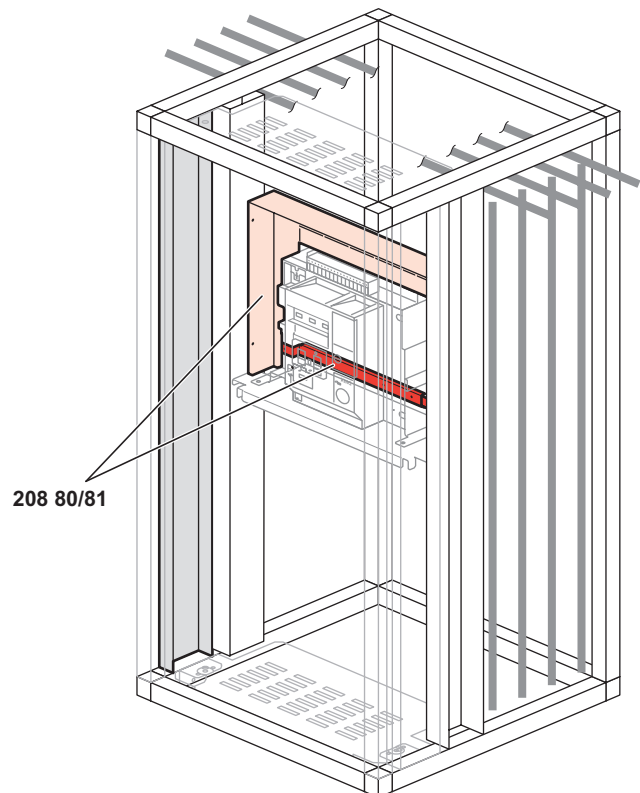

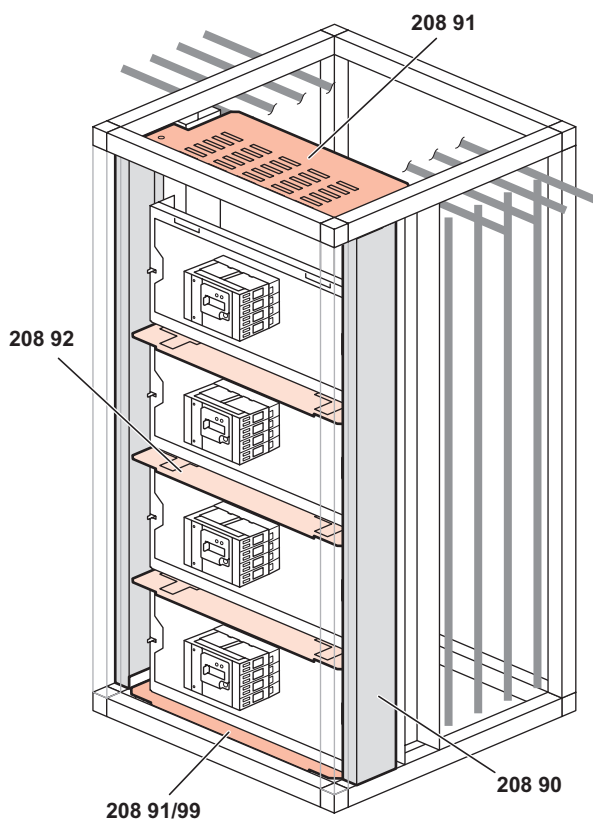
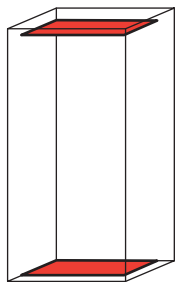

2a/3a

208 91

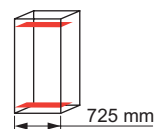

208 99

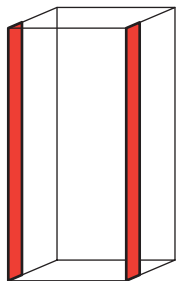
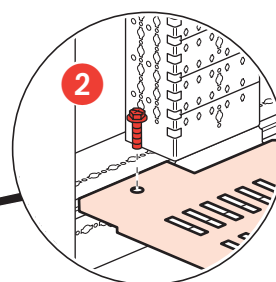
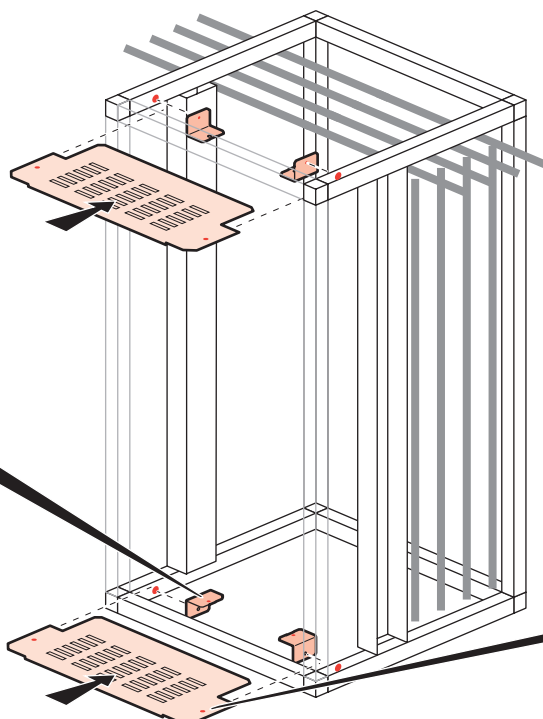
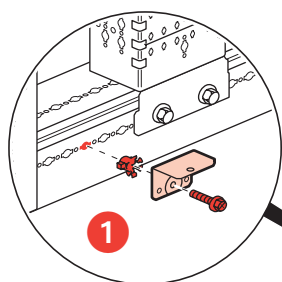
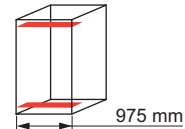

3a

208 90



x 12



M6 x 12

x 12

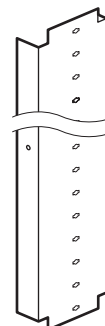

x 2

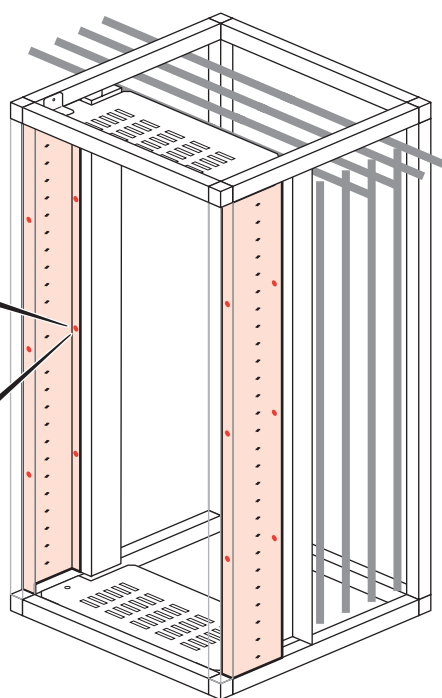
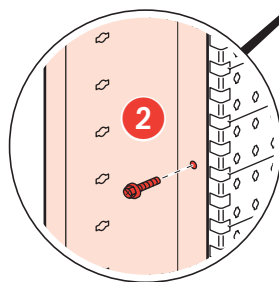
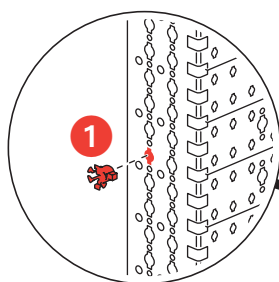

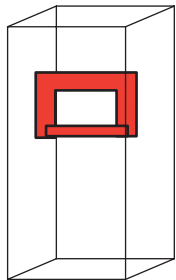

2a/3a

208 80/81

 x 4

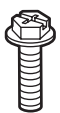
 M6 x 12
x 7

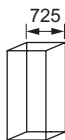
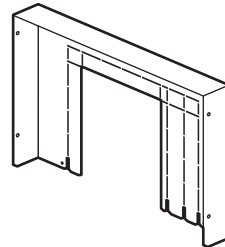
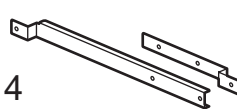

208 80 ⇒ DMX 2500

208 81 ⇒ DMX 2500

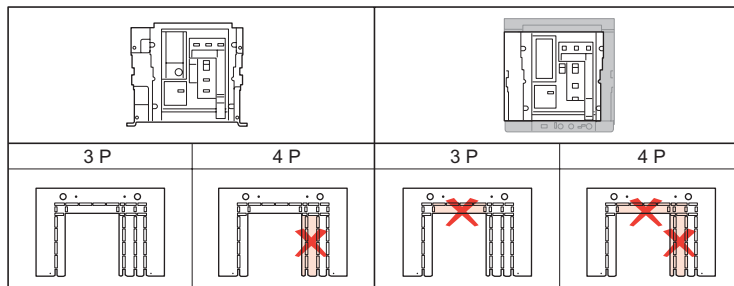
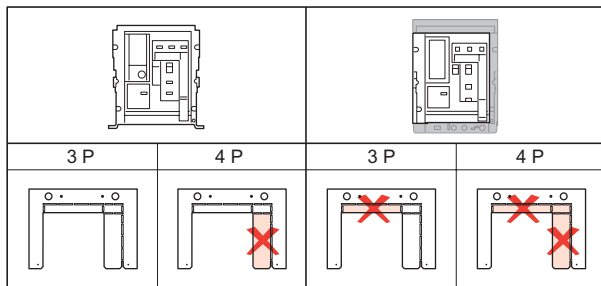

208 81 ⇒ DMX-L 2500/DMX-L 4000/DMX 4000

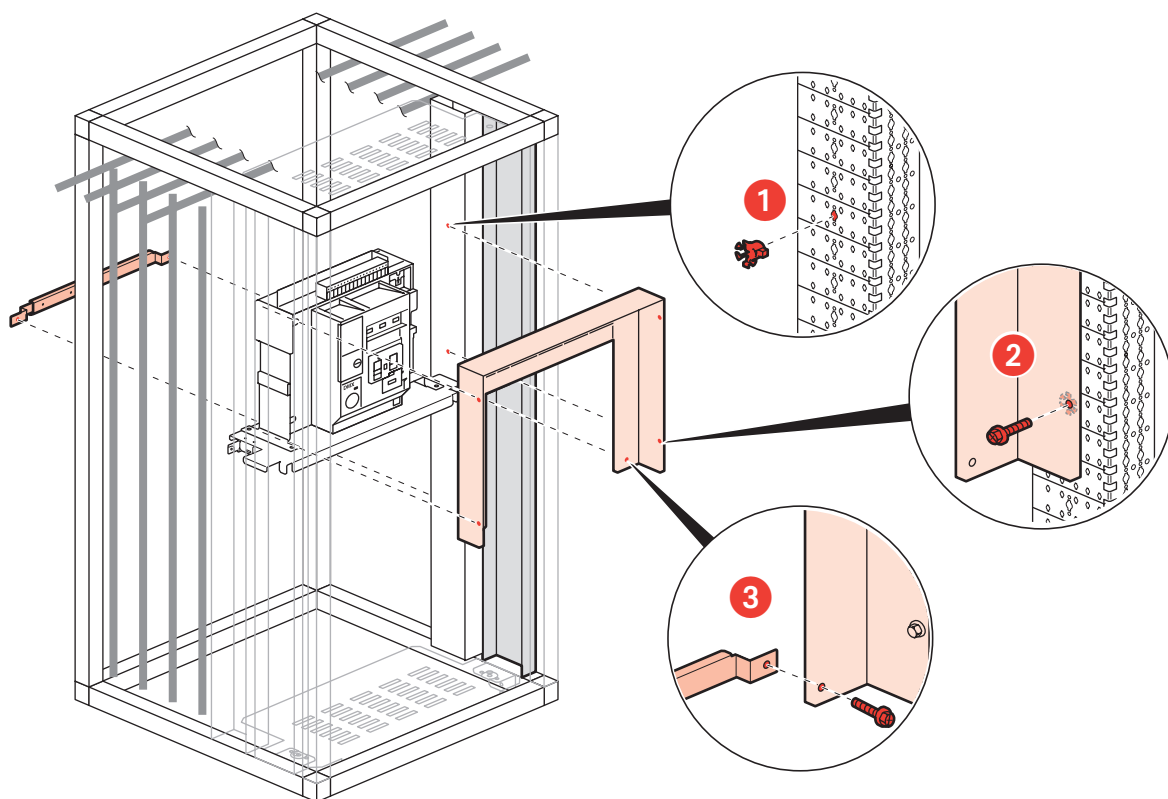
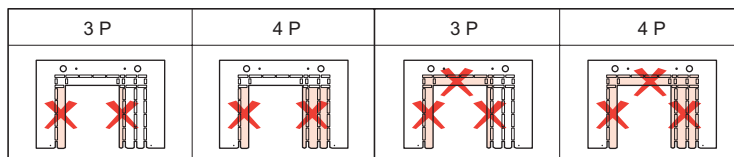

208 80

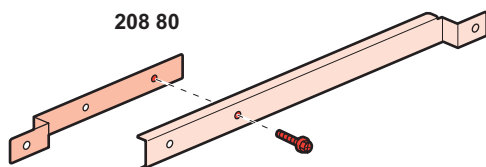

208 81

