

CONTENTS

Page

1. Use	1
2. Technical features	1
3. Dimensions	2
4. Connection	3
5. Operation	6
6. Standards and approvals	6
7. Maintenance	6
8. Communication objects	7

1. USE

The KNX multi-application modular controller has been specially designed to meet requirements for control in hotel rooms and meeting rooms.

It comprises:

- 16 binary outputs that can be configured to control lighting (2 blocks of 4 relays: 4.3 A max. to be distributed in each of the blocks), blinds (2 blocks of 2 relays: 2.1 A max. to be distributed in each of the blocks) and power sockets (2 blocks of 2 relays: 16 A max. to be distributed in each of the blocks). Each output can be part of 5 scenarios and 3 different modes. 4 separate current measurements are incorporated.
- 16 configurable auxiliary inputs for ON/OFF, Dim +/-, scene and raise/lower/stop commands for roller blinds via switches, pushbuttons or other volt-free contact devices.
- One DALI dimming output:
- In broadcast mode

The DALI output can supply up to 20 ballasts (max. bus consumption 40 mA) or up to 64 ballasts with the addition of an external DALI power supply.

- Functions for creating scenarios and advanced logic functions: 3 logic "blocks" for sending a command according to 3 conditions and 3 other "program blocks" for sending 5 different actions on 1 command.

2. TECHNICAL FEATURES

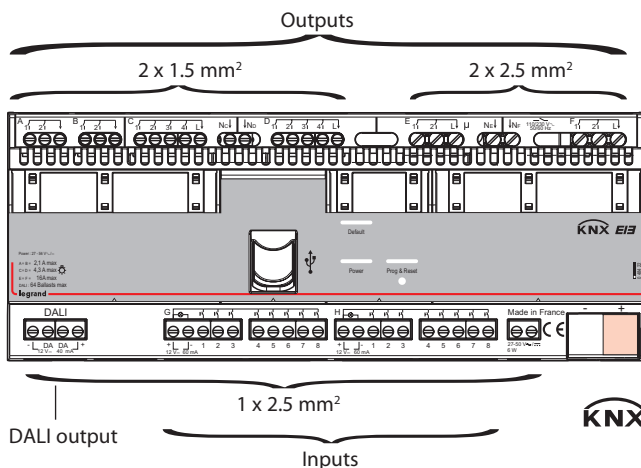

- Important:** Neutral terminals necessary for:
- Synchronisation with the mains power supply
 - Measurement of energy consumption

2. TECHNICAL FEATURES (CONTINUED)

Device power supply	27-50 V~ / - 6 W
Terminal type	Screw
Number of load terminals	16 outputs { A - B: 2.1 A blocks C - D: 4.3 A blocks E - F: 16 A blocks
Number of auxiliary input terminals	16 inputs (G - H: 8-input blocks)
Capacity of the load terminals	2 x 1.5 mm ² (A to D) 2 x 2.5 mm ² (E to F)
Capacity of the DALI load terminals	1 x 2.5 mm ²
Capacity of the auxiliary input terminals	1 x 2.5 mm ²
KNX connection	0.6 to 0.8 mm ²
Contact type	Bistable relay (blocks E & F), monostable relay (blocks A, B, C & D)
Location category	Indoor
Degree of protection	IP 20
Penetration by solid and liquid matter	(installation in an enclosure)
Impact resistance	IK 04
Number of modules	12
Usage temperature	-5°C to +45°C
Storage temperature	-20°C to +70°C
No-load power consumption	< 1 W
KNX/BUS absorption	5 mA
Weight	387 g

2. TECHNICAL FEATURES (CONTINUED)

Outputs A - B	230 V~	80 VA	0.3 A	250 VA	1.1 A	250 VA	1.1 A	2 (2 x 36) W	0.8 A	80 VA	0.3 A	80 VA	0.3 A	500 W	2.1 A	250 VA	1.1 A	250 VA	1.1 A
	110 V~	40 VA		125 VA		125 VA		1 (2 x 36) W		40 VA		40 VA		250 W		125 VA		125 VA	
	12 - 48 V~/V=	4-15 VA	0.3 A													13-52 VA	1.1 A	13-52 VA	1.1 A
Outputs C - D	230 V~	160 VA	0.7 A	500 VA	2.1 A	500 VA	2.1 A	4 (2 x 36) W	1.7 A	160 VA	0.7 A	160 VA	0.7 A	1000 W	4.3 A	500 VA	2.1 A	500 VA	2.1 A
	110 V~	80 VA		250 VA		250 VA		2 (2 x 36) W		80 VA		80 VA		500 W		250 VA		250 VA	
Outputs E - F	230 V~	500 VA	2.1 A	1000 VA	4.3 A	1000 VA	4.3 A	10 (2 x 36) W	4.3 A	500 VA	2.1 A	500 VA	2.1 A	3680 W	16 A	500 VA	2.1 A	500 VA	2.1 A
	110 V~	250 VA		500 VA		500 VA		5 (2 x 36) W		250 VA		250 VA		1760 W		250 VA		250 VA	

- 1 LED bulbs
- 2 ELV halogen, compact fluorescent and fluorescent bulbs with separate electronic ballast
- 3 ELV halogen, compact fluorescent and fluorescent bulbs with separate ferromagnetic ballast
- 4 Fluorescent tubes
- 5 Compact fluorescent bulbs with built-in electronic ballast
- 6 Compact fluorescent bulbs with built-in ferromagnetic ballast
- 7 Halogen bulbs
- 8 Motors
- 9 Contactors

Power supply unit

The device must be powered by an external power supply. Permitted voltage range: 27 to 50 V~/V=, 6 W min.

Power outputs

-Blocks A and B (2 blocks of 2 relays: 2.1 A max. to be distributed in each of the blocks).
For roller blind control functions, exclusive signs (e.g. Do not disturb/Room service) and ON/OFF functions (for AC or DC load).
-Blocks C and D (2 blocks of 4 relays: 4.3 A max. to be distributed in each of the blocks).
For controlling 4 separate loads per block. Each block includes energy measurement.
-Blocks E and F (2 blocks of 2 relays: 16 A max. to be distributed in each of the blocks).
For controlling 2 separate loads per block. Each block includes energy measurement.

DALI output

For controlling 64 DALI ballasts in Broadcast mode. Pairing between the device and the DALI output is not necessary. The DALI BUS power supply is incorporated in the device. I_{max} 40 mA/12 V= (20 ballasts max). If I is greater than 40 mA, use an external power supply (remove the jumpers from the DALI terminals).

Control inputs

- Blocks G and H.
The device has 2 blocks each one having power supply output (12 V=) and 8 auxiliary inputs. Switches or pushbuttons can be connected to the inputs in order to send ON/OFF, dimming, shutter raising/lowering or scenario control commands, their settings can be configured using the ETS configuration software. The power supply enables the controls to have pilot lights (standby).

3. DIMENSIONS

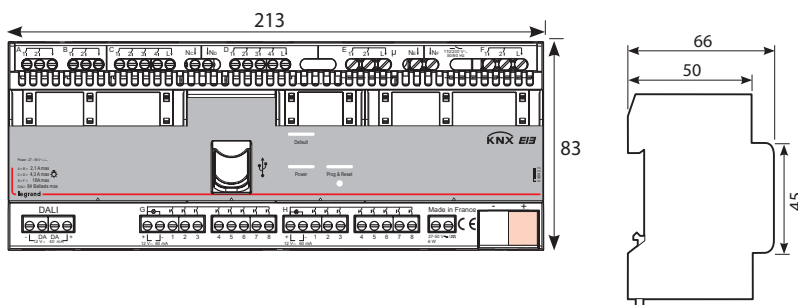

4. CONNECTION

• Single phase

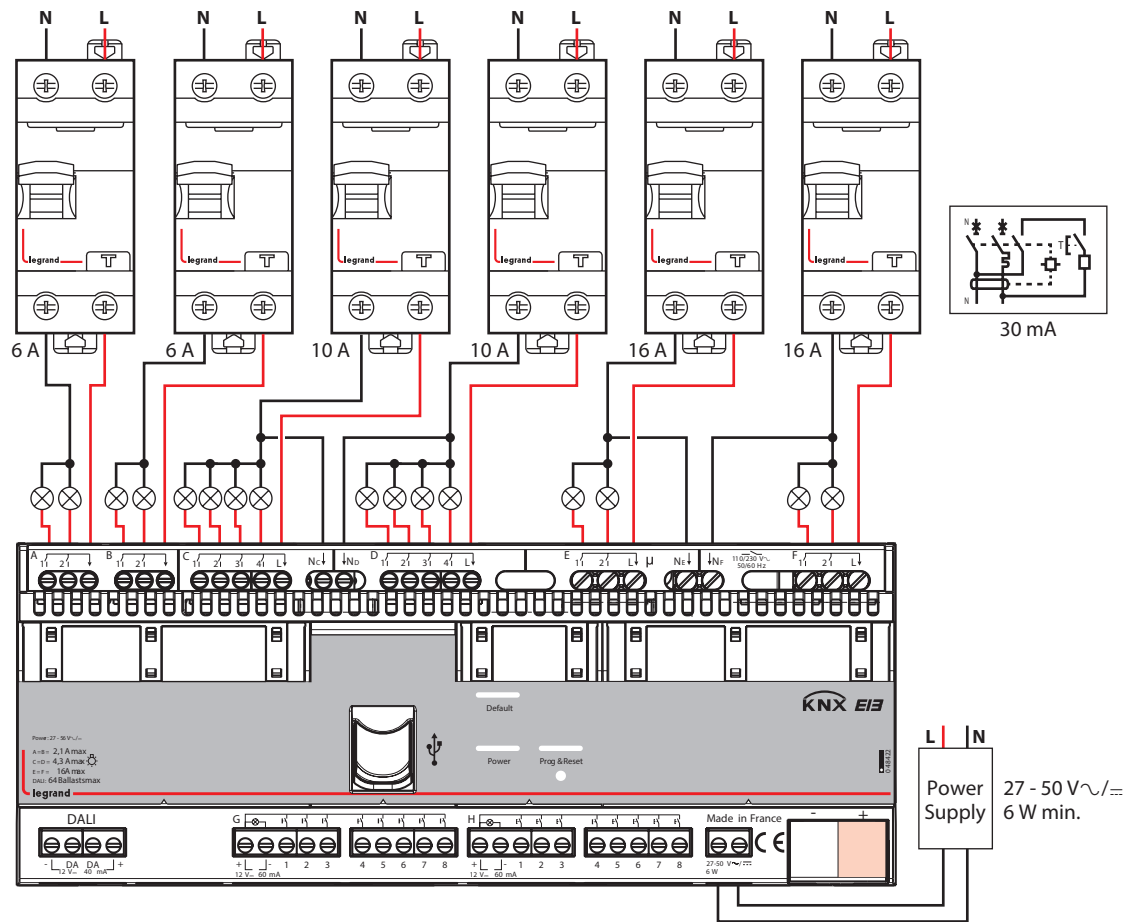

4. CONNECTION (CONTINUED)

• Single phase

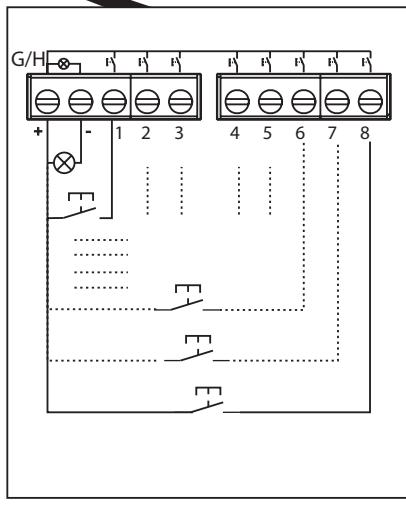
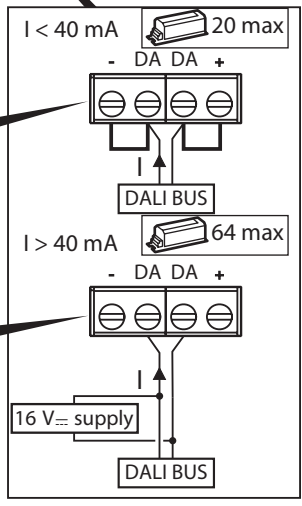
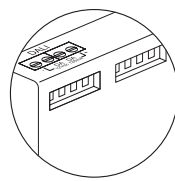
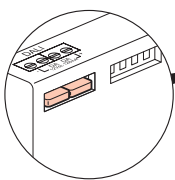
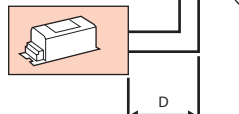
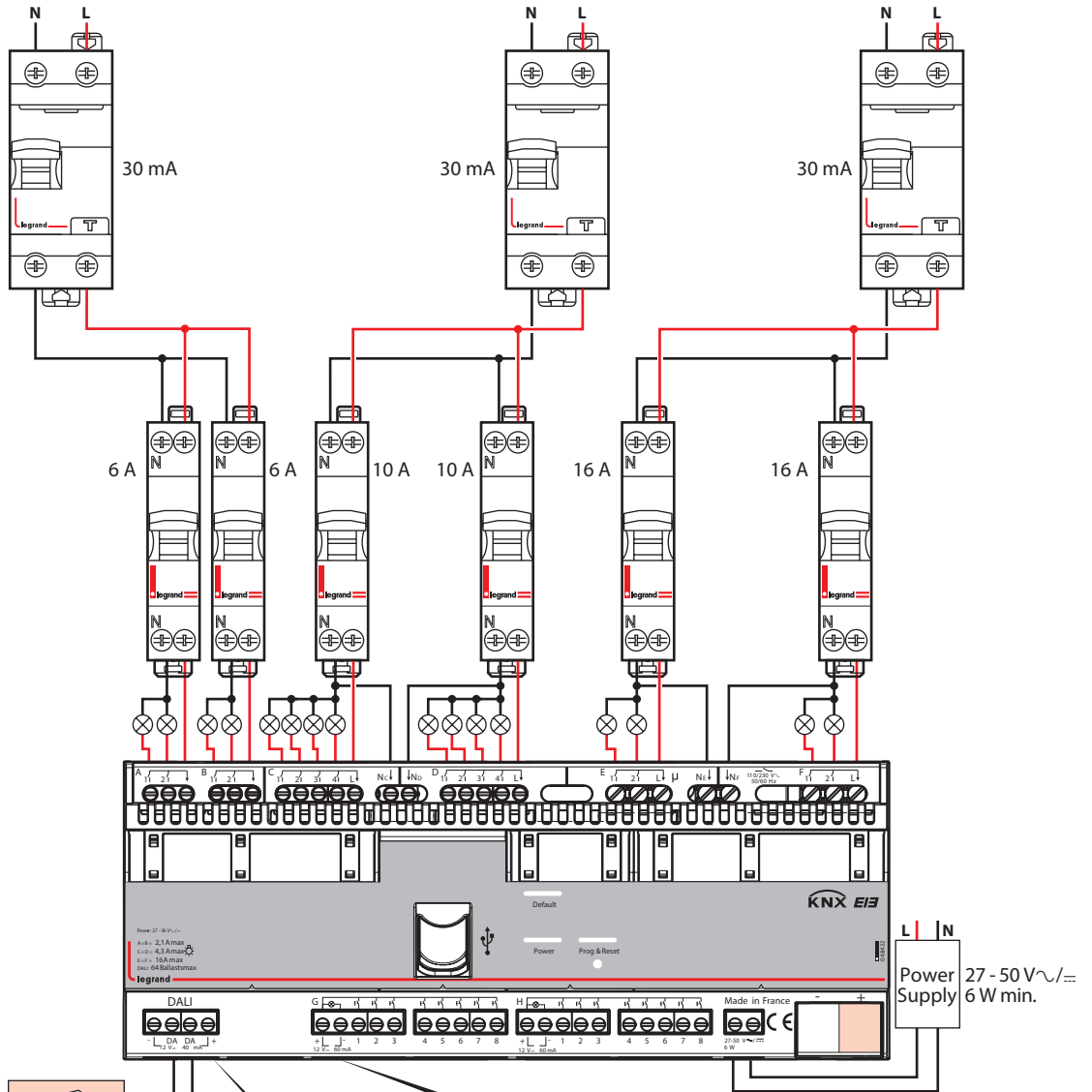

D	Ø
≤ 100 m	0.5 mm ²
≤ 150 m	0.75 mm ²
≤ 300 m	1.5 mm ²

The room controller has a 12 V - 128 mA power supply for the DALI output. With the jumpers connected, it can power the DALI BUS.

4. CONNECTION (CONTINUED)

• Three-phase

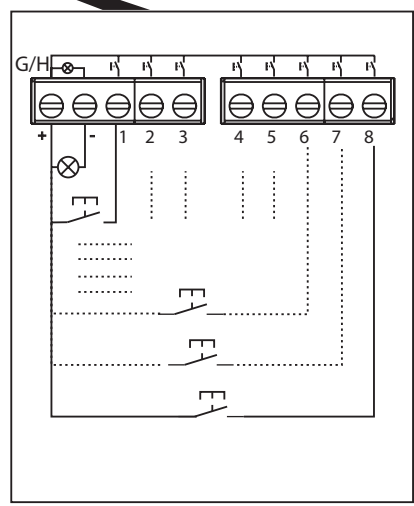
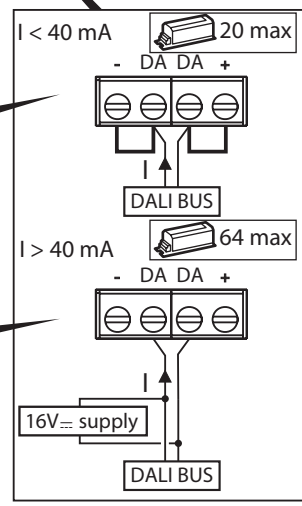
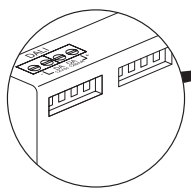
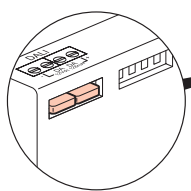
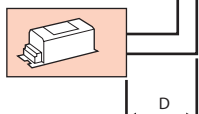
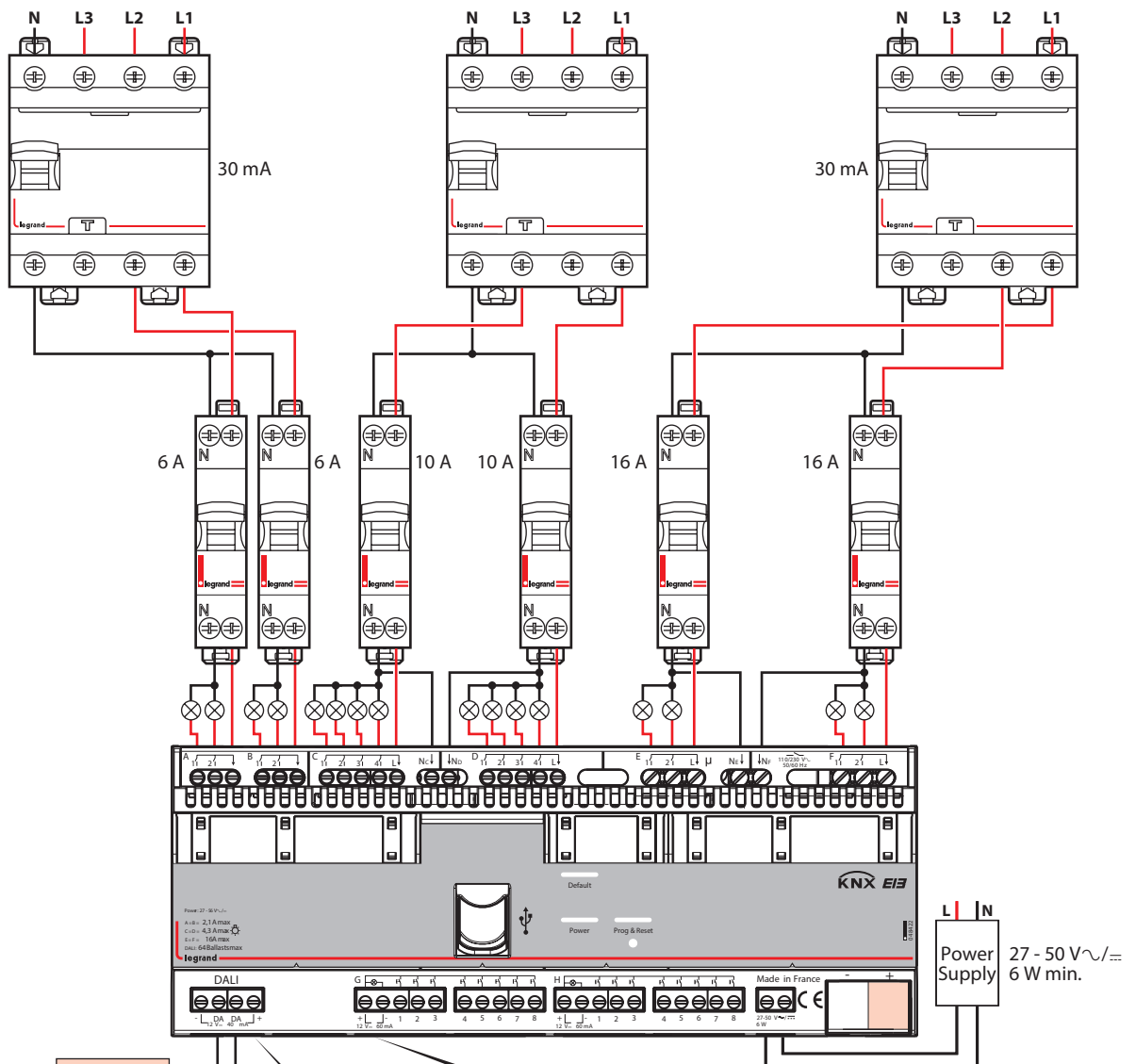

D	Ø
≤ 100 m	0.5 mm ²
≤ 150 m	0.75 mm ²
≤ 300 m	1.5 mm ²

The room controller has a 12 V - 128 mA power supply for the DALI output. With the jumpers connected, it can power the DALI BUS.

5. OPERATION

All device settings must be done using the ETS software tool (version 3f or later).

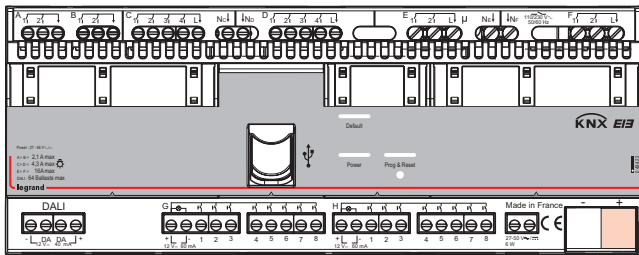

Power LED Power

- ON steady: an ETS application is programmed
- Flashing in 3-flash cycles: default settings (no ETS application programmed)
- Flashing in 1-flash cycles: the device is initialising
- OFF:
- USB not connected: the device is not powered by the external power supply.
- USB connected and device powered: the device is awaiting a software update

Default settings (without ETS configuration)

Outputs A and B are configured by default for roller blind operation (30 s time delay).
 Outputs C1 to F2 are configured by default for ON/OFF with no time delay.
 Inputs G1 to H8 are configured by default for switch operation.
 The actions of the default settings are defined in the table below.

Inputs	G1	G2	G3	G4	G5	G6	G7	G8	H1	H2	H3	H4	H5	H6	H7	H8
Outputs	A1/A2	B1/B2	C1	C2	C3	C4	D1	D2	D3	D4	E1	E2	F1	F2	DALI	DALI
Action	UP/ DOWN	UP/ DOWN	ON/ OFF	ON/ OFF	ON/ OFF	ON/ OFF	ON/ OFF	ON/ OFF	ON/ OFF	ON/ OFF	ON/ OFF	ON/ OFF	ON/ OFF	ON/ OFF	100%/ OFF	100%/ OFF

“Fault” LED Default

- ON: indicates a fault. The device must be restarted by switching the power off and then back on.
- Flashing: the device is “busy”. Do not switch off the power supply
- OFF: no fault

Programming & Reset LED Prog & Reset

- OFF: the device is not in programming mode.
- Short press (less than 1 second):
- On steady: the device is in programming mode and the KNX cable is correctly connected/powerd
- Flashing (1 cycle of 3 flashes): the KNX cable is not correctly connected/powerd. The device is not in programming mode
- Short press (less than 1 second) + long press (10 seconds): restoration of default settings. All the LEDs flash during the reset phase

USB (do not use)

Reserved for firmware update by the manufacturer.

6. STANDARDS AND APPROVALS

- Conforme: CE
- Product standards: IEC 60669-2-1
- Environmental standards:
 - EU directive 2002/96/EC: WEEE (Waste Electrical and Electronic Equipment)
 - EU directive 2002/95/EC: RoHS (Restriction of Hazardous Substances)
 - Regulations: ERP (public buildings)
 - ERT (workplace buildings)
 - IGH (high-rise buildings)
- KNX certificate n° 11/11130/13

7. MAINTENANCE

Do not use acetone, tar-removing cleaning agents or trichloroethylene.
 Resistant to the following products: - Hexane (En 60669-1)

- Methylated spirit
- Soapy water
- Diluted ammonia
- Bleach diluted to 10%
- Window-cleaning products

Caution: Always test before using other special cleaning products.

8. COMMUNICATION OBJECTS

8.1 Inputs

Inputs can each be used as "Inputs, separately configurable" or as "Inputs, jointly configurable". According to this setting the available functions and objects change.

8.1.1 Use separately

Not used

Input is not usable, no accessible communication objects

Switching

Usage	Use separately
G1 : Main function	Switching

The following objects are automatically inserted:

No.	Object name	Function	Size	Flags
2 (9, 16, 23, 30, 37, 44, 51, 58, 65, 72, 79, 86, 93, 100, 107)	Input G(,H)1 (2 → 8)	Switching	1.001 DPT_Switch	CWT
Switching telegrams are sent via the group address linked with this object				
3 (10, 17, 24, 31, 38, 45, 52, 59, 66, 73, 80, 87, 94, 101, 108)	Input G(,H)1 (2 → 8)	Switching Status	1.001 DPT_Switch	CW
Switching states are received via the group address linked with this object. They are only visible if "Add status object" parameter value is set to yes.				
4 (11, 18, 25, 32, 39, 46, 53, 60, 67, 74, 81, 88, 95, 102, 109)	Input G(,H)1 (2 → 8)	Enable	1.003 DPT_Enable	CW
Enable telegrams are received via the group address linked with this object. They are used to lock (disable) or unlock (enable) the corresponding input. They are only visible if "Add enable object" parameter value is set to yes.				

• Switch

Usage	Use separately
G1 : Main function	Switching
Function	Switch
Switching value when contact is closed	On
Switching value when contact is opened	Off
Add Status Object	No
Contact type	Normally open contact
Add enable object	No

This function is used, for binary inputs to which a switch button is attached, to send a switching telegram (ON, OFF or TOGGLE) as a reaction to a rising and / or falling signal edge at this input. Each time the push button is pressed and / or released resp. the contact is closed and / or opened a telegram is sent, i.e. this function can be used e.g. to implement the behavior of a bell switch.

Parameters	Setting
Switching value when contact is closed	No reaction On Off Toggle
Here an adjustment is made to define which switching value is written into the storage cell of the communication object and sent after a rising edge in the signal status at the channel (input). The rising edge corresponds to a change in the signal status at the input from logical "0" to "1". "No reaction": An edge change at the input does not change the object value and also does not send a telegram. "On": In the event of a rising edge the switching value "ON" (binary value, "1") is transferred into the communication object and sent. "Off": In the event of a rising edge the switching value "OFF" (binary value, "0") is transferred into the communication object and sent. "Toggle": In the event of a rising edge, the switching value stored in the communication object is inverted and the new value is sent.	
Switching value when contact is opened	No reaction On Off Toggle
Here an adjustment is made to define which switching value is written into the storage cell of the communication object and sent after a falling edge in the signal status at the channel (input). The falling edge corresponds to a change in the signal status at the input from logical "1" to "0". "No reaction": An edge change at the input does not change the object value and also does not send a telegram. "On": In the event of a rising edge the switching value "ON" (binary value, "1") is transferred into the communication object and sent. "Off": In the event of a rising edge the switching value "OFF" (binary value, "0") is transferred into the communication object and sent. "Toggle": In the event of a rising edge, the switching value stored in the communication object is inverted and the new value is sent.	
Add status object	Yes / No
The parameter determines if an additional communication object (status) shall be used to perform toggle functionality or other purposes.	
Contact type	Normally open contact Normally closed contact
The contact type of the input connected to the channel is adjusted here. "Normally open contact": the contact of the input is active when closed, inactive when opened. "Normally closed contact": the contact of the input is active when opened, inactive when closed.	
Add enable object	Yes / No
The parameter determines if the input can be blocked via an additional Enable object or not. If an input is blocked (Enable value = 1) the status changes at this input are not transmitted.	

• Push

Usage	Use separately
G1 : Main function	Switching
Function	Push
Short push reaction	Toggle
Long push reaction	No reaction
Long push action min.	2 seconds
Add Status Object	No
Contact type	Normally open contact
Add enable object	No

8. COMMUNICATION OBJECTS (CONTINUED)

This function is used, for binary inputs to which a push button is attached, to send a switching telegram (ON, OFF or TOGGLE) as a reaction to a short or long push button action, i.e. this function can be used e.g. to recall a scene.

Parameters	Setting
Short push reaction	No reaction On Off Toggle
Here an adjustment is made to define which switching value is written into the storage cell of the communication object and sent after short pressing of the push attached to the input. "No reaction" : A short push button action does not change the object value and also does not send a telegram. "On" : After a short push, the switching value "ON" (binary value, "1") is transferred into the communication object and sent. "Off" : After a short push, the switching value "OFF" (binary value, "0") is transferred into the communication object and sent. "Toggle" : After a short push, the switching value stored in the communication object is inverted and the new value is sent.	
Long push reaction	No reaction On Off Toggle
Here an adjustment is made to define which switching value is written into the storage cell of the communication object and sent after long pressing the push button attached to the input. "No reaction" : A long push does not change the object value and also does not lead to the sending of a telegram. "On" : After a long push, the switching value "ON" (binary value, "1") is transferred into the communication object and sent. "Off" : After a long push, the switching value "OFF" (binary value, "0") is transferred into the communication object and sent. "Toggle" : After a long push, the switching value stored in the communication object is inverted and the new value is sent.	
Long push action min.	0.5 second 1 second 2 seconds 3 seconds 4 seconds 5 seconds 10 seconds
This parameter determines the minimum period for detecting a long push.	
Add status object	Yes / No
The parameter determines if an additional communication object (status) shall be used to perform toggle functionality or other purposes.	
Contact type	Normally open contact Normally closed contact
The contact type of the input attached to the channel is adjusted here. "Normally open contact" : the contact of the input is active when closed, inactive when opened. "Normally closed contact" : the contact of the input is active when opened, inactive when closed.	
Add enable object	Yes / No
The parameter determines if the input can be blocked via an additional Enable object or not. If an input is blocked (Enable value = 0) the status changes at this input are not transmitted.	

Shutter 1-input

No.	Object name	Function	Size	Flags
2 (9, 16, 23, 30, 37, 44, 51, 58, 65, 72, 79, 86, 93, 100, 107)	Input G,(H)1 (2 → 8)	Shutter Up/Down	1.008 DPT_UpDown	CWT
The movement commands Up/Down are sent via the address linked with this object in order to raise/lower the solar protection.				
8 (15, 22, 29, 36, 43, 50, 57, 64, 71, 78, 85, 92, 99, 106, 113)	Input G,(H)1 (2 → 8)	Shutter Stop - slats	1.009 DPT_OpenClose	CWT
The command "STOP" or "Slats OPEN/CLOSE" are sent via the group address linked with this object.				
4 (11, 18, 25, 32, 39, 46, 53, 60, 67, 74, 81, 88, 95, 102, 109)	Input G,(H)1 (2 → 8)	Enable	1.003 DPT_Enable	CW
Enable telegrams are received via the group address linked with this object. They are used to lock (disable) or unlock (enable) the corresponding input. They are only visible if "Add enable object" parameter value is set to yes.				

• Switch

Usage	Use separately
G1 : Main function	Shutter 1-input
Function	Switch
Switching value when contact is closed	Up
Switching value when contact is opened	Stop
Contact type	Normally open contact
Add enable object	No

This function allows using just one switch for moving a shutter up or down and to stop its motion. To achieve this a distinction is made between closed and open contact action.

8. COMMUNICATION OBJECTS (CONTINUED)

Parameters	Setting
Switching value when contact is closed	No reaction Up Down
Here an adjustment is made to define which movement command is written into the storage cell of the communication object and sent after a rising edge. The rising edge corresponds to a change in the signal status at the input from logical "0" to "1". "No reaction": action does not change the object value and also does not send a telegram. "Up": when the contact is active, the command UP is transferred into the communication object and sent. "Down": when the contact is active, the command DOWN is transferred into the communication object and sent.	
Switching value when contact is opened	No reaction Stop
Here an adjustment is made to define which switching movement command is written into the storage cell of the communication object and sent after a falling edge in the signal status at the channel (input). The falling edge corresponds to a change in the signal status at the input from logical "1" to "0". "No reaction": action does not change the object value and also does not send a telegram. "Stop": when the contact is inactive, the command stop is transferred into the communication object and sent.	
Contact type	Normally open contact Normally closed contact
The contact type of the input attached to the channel is adjusted here. "Normally open contact": the contact of the input is active when closed, inactive when opened. "Normally closed contact": the contact of the input is active when opened, inactive when closed.	
Add enable object	Yes / No
The parameter determines if the input can be blocked via an additional Enable object or not. If an input is blocked (Enable value = 0) the status changes at this input are not transmitted.	

• Push

Usage	Use separately
G1 : Main function	Shutter 1-input
Function	Push
Short push reaction	Stop
Long push reaction	Cyclical Up/Down
Long push release	No reaction
Long push button action min.	2 seconds
Contact type	Normally open contact
Add enable object	No

This function allows using just one push button for moving shutter up and down, stopping of the motion and opening and closing of the slats. To achieve this a distinction is made between short and long push action.

Parameters	Setting
Short push reaction	No reaction Cyclical Up / Down + stop Up + stop Down + stop Cyclical Up / Down Stop Open slats Close slats Up Down
Here an adjustment is made to define which movement command is written into the storage cell of the communication object and sent after a short press the push button attached to the input. "No reaction": action does not change the object value and also does not send a telegram. Cyclical Up / Down + stop: each short push transfers the following sequence command values into the communication object: Up, Stop, Down, Stop, Up, Stop, Down, Stop, etc. Up + stop: each short push transfers the following sequence command values into the communication object: Up, Stop, Up, Stop, etc. Down + stop: each short push transfers the following sequence command values into the communication object: Up, Stop, Up, Stop, etc. Cyclical Up / Down: each short push transfers the following sequence command values into the communication object: Up, Down, Up, Down, etc. Stop: a short push transfers into the communication object the stop command value ("1" or "0"). Open slats: a short push transfers into the communication object the stop (open slats) command value ("0"). Close slats: a short push transfers into the communication object the stop (close slats) command value ("1"). Up: a short push transfers into the communication object the Up command (value "0"). Down: a short push transfers into the communication object the Down command (value "1").	
Long push reaction	No reaction Up Down Cyclical Up/Down Stop Cyclical Open/Close slats Open slats Close slats
Here an adjustment is made to define which movement command is written into the storage cell of the communication object and sent after long pressing the push button attached to the input. "No reaction": action does not change the object value and also does not send a telegram. Up: a long push action transfers into the communication object the Up command (value "0"). Down: a long push action send the Down command (value "1") Cyclical Up / Down: each push sends only one telegram as toggle reaction depending on the previous value: Up, Down, Up, Down, etc. Stop: a long push action sends the stop command (value "1" or "0") Cyclical Open /Close slats: on each long push, the same telegram is sent every 800ms as long as the contact is closed (or opened, depending on the "Normally open/closed contact" parameters value). The value transferred into the communication object alternates between "Open" and "Close", depending on the previous value. Open slats: a long push action transfers into the communication object the stop (open slats) command (value "0"). Close slats: a long push action transfers into the communication object the stop (close slats) command (value "1").	

8. COMMUNICATION OBJECTS (CONTINUED)

Parameters	Setting
Long push release	No reaction Stop
Here an adjustment is made to define which value is written into the storage cell of the communication object and sent when releasing the push button after a long press. No reaction: action does not change the object value and also does not send a telegram. Stop: the stop command (value "1" or "0") is transferred into the communication object and sent.	
Long push action min.	0.5 second 1 second 2 seconds 3 seconds 4 seconds 5 seconds 10 seconds
This parameter determines the minimum period for detecting a long push.	
Add status object	Yes / No
The parameter determines if an additional communication object (status) shall be used to realize toggle functionality or other purposes.	
Contact type	Normally open contact Normally closed contact
The contact type of the input attached to the channel is adjusted here. "Normally open contact": the contact of the input is active when closed, inactive when opened. "Normally closed contact": the contact of the input is active when opened, inactive when closed.	
Add enable object	Yes / No
The parameter determines if the input can be blocked via an additional Enable object or not. If an input is blocked (Enable value = 0) the status changes at this input are not transmitted.	

8-bits scene control

No.	Object name	Function	Size	Flags
5 (12, 19, 26, 33, 40, 47, 54, 61, 68, 75, 82, 89, 96, 103, 110)	Input G(H)1 (2 → 8)	8-bits scene	17.001 DPT_Scene- Number	CT
The telegrams to recall the scene with the configured number (between 1 and 64) are sent via the group address link with this object.				
4 (11, 18, 25, 32, 39, 46, 53, 60, 67, 74, 81, 88, 95, 102, 109)	Input G(H)1 (2 → 8)	Enable	1.003 DPT_ Enable	CW
Enable telegrams are received via the group address linked with this object. They are used to lock (disable) or unlock (enable) the corresponding input. They are only visible if "Add enable object" parameter value is set to yes.				

• Switch

Usage: Use separately

G1 : Main function: 8-bits scene control

Function: Switch

Scene num. on rising edge: 1

Scene num. on falling edge: 1

Contact type: Normally open contact

Add enable object: No

Using one button, the scene with the configured number (between 1 and 64) can be recalled via a short push.
If Scene number is set to the value "0", no scene is going to be recalled.

Parameters	Setting
Scene num. on rising edge	1 → 64
This parameters determines which scene (between 1 and 64) is to be recalled on rising edge. If value "0" is set, no scene is going to be recalled	
Scene num. on falling edge	1 → 64
This parameters determines which scene (between 1 and 64) is to be recalled on falling edge If value "0" is set, no scene is going to be recalled	
Contact type	Normally open contact Normally closed contact
The contact type of the input attached to the channel is adjusted here. "Normally open contact": the contact of the input is active when closed, inactive when opened. "Normally closed contact": the contact of the input is active when opened, inactive when closed.	
Add enable object	Yes / No
The parameter determines if the input can be blocked via an additional Enable object or not. If an input is blocked (Enable value = 0) the status changes at this input are not transmitted.	

• Push

Usage: Use separately

G1 : Main function: 8-bits scene control

Function: Push

Scene num. on rising edge: 1

Contact type: Normally open contact

Add enable object: No

Using one button, the scene with the configured number (between 1 and 64) can be recalled via a short push. If Scene number is set to the value "0", no scene is going to be recalled.

8. COMMUNICATION OBJECTS (CONTINUED)

Parameters	Setting
Scene num. on rising edge	1 → 64
This parameter determines which scene (between 1 and 64) is to be recalled on rising edge. If value "0" is set, no scene is going to be recalled.	
Contact type	Normally open contact Normally closed contact
The contact type of the input attached to the channel is adjusted here. "Normally open contact": the contact of the input is active when closed, inactive when opened. "Normally closed contact": the contact of the input is active when opened, inactive when closed.	
Add enable object	Yes / No
The parameter determines if the input can be blocked via an additional Enable object or not. If an input is blocked (Enable value = 0) the status changes at this input are not transmitted.	

Priority

No.	Object name	Function	Size	Flags
5 (12, 19, 26, 33, 40, 47, 54, 61, 68, 75, 82, 89, 96, 103, 110)	Input G,(H)1 (2 → 8)	Override 2bits	2.001 DPT_Switch_ Control	CT

The telegrams with the override commands are sent via the address linked with this object in order to raise/lower the solar protection.

4 (11, 18, 25, 32, 39, 46, 53, 60, 67, 74, 81, 88, 95, 102, 109)	Input G,(H)1 (2 → 8)	Enable	1.003 DPT_ Enable	CW
---	----------------------	--------	----------------------	----

Enable telegrams are received via the group address linked with this object. They are used to lock (disable) or unlock (enable) the corresponding input.

They are only visible if "Add enable object" parameter value is set to yes.

Value	Behaviour
00b	Low Priority, Off-State
01b	Low Priority, On-State
10b	High Priority, Off-State
11b	High Priority, On-State

• Switch

Usage	Use separately
G1 : Main function	Priority
Function	Switch
Value when contact is closed	Priority High / On
Value when contact is opened	Priority High / Off
Contact type	Normally open contact
Add enable object	No

This function is used for inputs with a switch to send a priority telegram, the contact is closed or opened, a telegram is sent.

Parameters	Setting
Value when contact is closed	Priority High / On Priority High / Off Priority Low / On Priority Low / Off
Here an adjustment is made to define which value is written into the storage cell of the communication object and sent after a rising edge in the signal status of the channel (input). The rising edge corresponds to a change in the signal status at the input from logical "0" to "1".	
Value when contact is opened	Priority High / On Priority High / Off Priority Low / On Priority Low / Off
Here an adjustment is made to define which value is written into the storage cell of the communication object and sent after a falling edge in the signal status of the channel (input). The falling edge corresponds to a change in the signal status at the input from logical "1" to "0".	
Contact type	Normally open contact Normally closed contact
The contact type of the input attached to the channel is adjusted here. "Normally open contact": the contact of the input is active when closed, inactive when opened. "Normally closed contact": the contact of the input is active when opened, inactive when closed.	
Add enable object	Yes / No
The parameter determines if the input can be blocked via an additional Enable object or not. If an input is blocked (Enable value = 0) the status changes at this input are not transmitted.	

• Push

Usage	Use separately
G1 : Main function	Priority
Function	Push
Short push reaction	Priority High / On
Long push reaction	Priority High / Off
Long push action min.	2 seconds
Contact type	Normally open contact
Add enable object	No

This function is used for inputs with a push button to send a priority telegram, the push is short or long, a telegram is sent.

8. COMMUNICATION OBJECTS (CONTINUED)

Parameters	Setting
Short push reaction	Priority High / On Priority High / Off Priority Low / On Priority Low / Off
Here an adjustment is made to define which positive drive value is written into the storage cell of the communication object and sent after short pressing the push button attached to the input.	
Long push reaction	Priority High / On Priority High / Off Priority Low / On Priority Low / Off
Here an adjustment is made to define which value is written into the storage cell of the communication object and sent after long pressing the push button attached to the input.	
Long push action min.	0.5 second 1 second 2 seconds 3 seconds 4 seconds 5 seconds 10 seconds
This parameter determines the minimum period for detecting a long push.	
Contact type	Normally open contact Normally closed contact
The contact type of the input attached to the channel is adjusted here. "Normally open contact": the contact of the input is active when closed, inactive when opened. "Normally closed contact": the contact of the input is active when opened, inactive when closed.	
Add enable object	Yes / No
The parameter determines if the input can be blocked via an additional Enable object or not. If an input is blocked (Enable value = 0) the status changes at this input are not transmitted.	

• Counting

Usage	Use separately
G1 : Main function	Counting
Minimum value	0
Maximum value	255
Increment / Decrement	Increment
Add "Reset counter" Object	No
Contact type	Normally open contact
Add enable object	No

No.	Object name	Function	Size	Flags
5 (12, 19, 26, 33, 40, 47, 54, 61, 68, 75, 82, 89, 96, 103, 110)	Input G,(H)1 (2 → 8)	Counting	5.010 DPT_Va- lue_1_ Ucount	CT
The telegrams with the counter value are sent via the group address linked with this object.				
3 (10, 17, 24, 31, 38, 45, 52, 59, 66, 73, 80, 87, 94, 101, 108)	Input G,(H)1 (2 → 8)	Reset Counter	1.015 DPT_Reset	CW
If a telegram linked with this object is received, then the counter value is reset to the minimum value set by the "minimum value" parameter.				
4 (11, 18, 25, 32, 39, 46, 53, 60, 67, 74, 81, 88, 95, 102, 109)	Input G,(H)1 (2 → 8)	Enable	1.003 DPT_ Enable	CW
Enable telegrams are received via the group address linked with this object. They are used to lock (disable) or unlock (enable) the corresponding input. They are only visible if "Add enable object" parameter value is set to yes.				

Parameters	Setting
Minimum value	0 → 255, 0
An adjustment is made via this parameter to define which minimum is the minimum possible counter value. In case of "decrement" value of "Increment decrement" parameter, the next counter value is set to the maximum value.	
Maximum value	0 → 255, 255
An adjustment is made via this parameter to define the maximum which is the maximum possible counter value. In case of "increment" value of "Increment decrement" parameter, the next counter value is set the minimum value.	
Increment / Decrement	Increment Decrement
Here an adjustment is made to define if the counter has to be incremented/decremented by 1 after each rising edge.	
Add "Reset counter" Object	Yes / No
This parameter determines if the "Reset Counter" object is visible or not	
Contact type	Normally open contact Normally closed contact
The contact type of the input attached to the channel is adjusted here. "Normally open contact": the contact of the input is active when closed, inactive when opened. "Normally closed contact": the contact of the input is active when opened, inactive when closed.	
Add enable object	Yes / No
The parameter determines if the input can be blocked via an additional Enable object or not. If an input is blocked (Enable value = 0) the status changes at this input are not transmitted.	

8. COMMUNICATION OBJECTS (CONTINUED)

Dimming

Usage	Use separately
G1 : Main function	Dimming
Switching value on short push	Toggle
Switching value on long push	On
Dimming value on long push	Dim +/-
Dimming value on release push	Stop
Long push button action min.	2 seconds
Add Status Object	No
Contact type	Normally open contact
Add enable object	No

No.	Object name	Function	Size	Flags
2 (9, 16, 23, 30, 37, 44, 51, 58, 65, 72, 79, 86, 93, 100, 107)	Input G,(H)1 (2 → 8)	Switching	1.001 DPT_Switch	CWT

Switching telegrams are sent via the group address linked with this object.
In the process, a short push button an ON, OFF or TOGGLE telegram.

6 (13, 20, 27, 34, 41, 48, 55, 62, 69, 76, 83, 90, 97, 104, 111)	Input G,(H)1 (2 → 8)	Dimming	3.007 DPT_Control_Dimming	CT
---	----------------------	---------	---------------------------	----

The dimming telegrams are sent to the dimming actuator via the group address linked with this object. In the process, a long push produces a "100% dimming" telegram. A stop command is sent when the push button is released if "Dimming value on release push" is set to "stop".

7 (14, 21, 28, 35, 42, 49, 56, 63, 70, 77, 84, 91, 98, 105, 112)	Input G,(H)1 (2 → 8)	Value Status	5.001 DPT_Scaling	CW
---	----------------------	--------------	-------------------	----

The dimming status telegrams are received from the dimming actuator via the group address linked with this object. This object is only visible when the parameter "Add status object" is set to "yes".

If Dimming value on long push is set to Dim+/-:
If the dimming actuator is at a dimming value between 1 and 99%, the dimming direction last enabled is inverted and then dimmed in the new direction. This allow several operation locations to synchronize and to always invert the last applied dimming direction.

Note:
If this object is not linked with a group address or the last dimming status has not been received when the push button is pressed, the dimming direction is inverted when Dimming value on long push is set to Dim+/-.

No.	Object name	Function	Size	Flags
4 (11, 18, 25, 32, 39, 46, 53, 60, 67, 74, 81, 88, 95, 102, 109)	Input G,(H)1 (2 → 8)	Enable	1.003 DPT_Enable	CW

Enable telegrams are received via the group address linked with this object. They are used to lock (disable) or unlock (enable) the corresponding input.

They are only visible if "Add enable object" parameter value is set to "Yes".

Parameters	Setting
Switching value on short push	No reaction On Off Toggle

Here an adjustment is made to define which switching value is written into the storage cell of the communication object and sent after short pressing the push button attached to the input.

"No reaction": A short push does not change the object value and also does not send a telegram.

"On": After short push, the switching value "ON" (binary value, "1") is transferred into the communication object and sent.

"Off": After short push, the switching value "OFF" (binary value "0") is transferred into the communication object and sent.

"Toggle": After short push, the switching value stored in the communication object is inverted and the new value is sent.

Switching value on long push	No reaction On
------------------------------	-------------------

Here an adjustment is made to define which switching value is written into the storage cell of the communication object and sent after long pressing the push button attached to the input.

"No reaction": A short push does not change the object value and also does not send a telegram.

"On": After short push, the switching value "ON" (binary value, "1") is transferred into the communication object and sent.

Dimming value on long push	Dim +/- Dim + Dim - No reaction
----------------------------	--

Here an adjustment is made to define which dimming value is written into the storage cell of the communication object and sent after long pressing the push button attached to the input.

"No reaction": A long push does not change the object value and also does not send a telegram.

"Dim+/-": After long push, the dimming value stored in the communication object is inverted and the new value is sent.

"Dim+": After short push, the dimming value "Increase 100%" is transferred into the communication object and sent.

"Dim-": After short push, the dimming value "Decrease 100%" is transferred into the communication object and sent.

Dimming value on push release	No reaction Stop
-------------------------------	---------------------

Here an adjustment is made to define which dimming value is written into the storage cell of the communication object and sent when releasing a push button after a long press.

"No reaction": A long push does not change the object value and also does not send a telegram.

"Stop": When the push button is released after a long push, the dimming value "Stop" is transferred into the communication object and sent.

8. COMMUNICATION OBJECTS (CONTINUED)

Parameters	Setting
Long push action min.	0.5 second 1 second 2 seconds 3 seconds 4 seconds 5 seconds 10 seconds
This parameter determines the minimum period for detecting a long push.	
Add status object	Yes / No
The parameter determines if an additional communication object (status) shall be used to perform toggle functionality or other purposes.	
Contact type	Normally open contact Normally closed contact
The contact type of the input attached to the channel is adjusted here. "Normally open contact": the contact of the input is active when closed, inactive when opened. "Normally closed contact": the contact of the input is active when opened, inactive when closed.	
Add enable object	Yes / No
The parameter determines if the input can be blocked via an additional Enable object or not. If an input is blocked (Enable value = 0) the status changes at this input are not transmitted.	

1 x 1 unsigned byte

Usage	Use separately
G1 : Main function	1 x 1 unsigned byte
Byte value on short push	1
Contact type	Normally open contact
Add enable object	No

No.	Object name	Function	Size	Flags
5 (12, 19, 26, 33, 40, 47, 54, 61, 68, 75, 82, 89, 96, 103, 110)	Input G,(H)1 (2 → 8)	Unsigned Value	5.010 DPT_ Value_1_ Ucount	CT

The telegrams with the unsigned value are sent via the group address linked with this object.

No.	Object name	Function	Size	Flags
4 (11, 18, 25, 32, 39, 46, 53, 60, 67, 74, 81, 88, 95, 102, 109)	Input G,(H)1 (2 → 8)	Enable	1.003 DPT_ Enable	CW

Enable telegrams are received via the group address linked with this object. They are used to lock (disable) or unlock (enable) the corresponding input.
They are only visible if "Add enable object" parameter value is set to yes.

Parameters	Setting
Byte value when contact is closed	0 → 255, 1
Here an adjustment is made to define which unsigned 8-bit value is written into the storage cell of the communication object and sent after a rising edge in the signal status at the channel (input). The rising edge corresponds to a change in the signal status at the input from logical "0" to "1".	
Contact type	Normally open contact Normally closed contact
The contact type of the input attached to the channel is adjusted here. "Normally open contact": the contact of the input is active when closed, inactive when opened. "Normally closed contact": the contact of the input is active when opened, inactive when closed.	
Add enable object	Yes / No
The parameter determines if the input can be blocked via an additional Enable object or not. If an input is blocked (Enable value = 0) the status changes at this input are not transmitted.	

2 x 1 unsigned byte

No.	Object name	Function	Size	Flags
5 (12, 19, 26, 33, 40, 47, 54, 61, 68, 75, 82, 89, 96, 103, 110)	Input G,(H)1 (2 → 8)	Unsigned Value	5.010 DPT_ Va- lue_1_ Ucount	CT

The telegrams with the unsigned value are sent via the group address linked with this object

No.	Object name	Function	Size	Flags
4 (11, 18, 25, 32, 39, 46, 53, 60, 67, 74, 81, 88, 95, 102, 109)	Input G,(H)1 (2 → 8)	Enable	1.003 DPT_ Enable	CW

Enable telegrams are received via the group address linked with this object. They are used to lock (disable) or unlock (enable) the corresponding input.

They are only visible if "Add status object" parameter value is set to yes.

• Switch

Usage	Use separately
G1 : Main function	2 x 1 unsigned byte
Function	Switch
Byte value when contact is closed	1
Byte value when contact is opened	0
Contact type	Normally open contact
Add enable object	No

This function is used for inputs with a switch to send a byte value telegram, the contact is closed or opened, a telegram is sent.

8. COMMUNICATION OBJECTS (CONTINUED)

Parameters	Setting
Byte value when contact is closed	0 → 255, 1
Here an adjustment is made to define which unsigned 8-bit value is written into the storage cell of the communication object and sent after a rising edge in the signal status at the channel (input). The rising edge corresponds to a change in the signal status at the input from logical "0" to "1".	
Byte value when contact is opened	0 → 255, 0
Here an adjustment is made to define which unsigned 8-bit value is written into the storage cell of the communication object and sent after a falling edge in the signal status at the channel (input). The falling edge corresponds to a change in the signal status at the input from logical "1" to "0".	
Contact type	Normally open contact Normally closed contact
The contact type of the input attached to the channel is adjusted here. "Normally open contact": the contact of the input is active when closed, inactive when opened. "Normally closed contact": the contact of the input is active when opened, inactive when closed.	
Add enable object	Yes / No
The parameter determines if the input can be blocked via an additional Enable object or not. If an input is blocked (Enable value = 0) the status changes at this input are not transmitted.	

• Push

Usage: Use separately

G1 : Main function: 2 x 1 unsigned byte

Function: Push

Byte value on short push: 1

Byte value on long push: 0

Long push action min.: 2 seconds

Contact type: Normally open contact

Add enable object: No

This function is used for inputs with a push button to send a byte value telegram, the push is short or long, a telegram is sent.

Parameters	Setting
Byte value on short push	0 → 255, 1
Here an adjustment is made to define which unsigned 8-bit value is written into the storage cell of the communication object and sent after short pressing the push button attached to the input.	
Byte value on long push	0 → 255, 0
Here an adjustment is made to define which unsigned 8-bit value is written into the storage cell of the communication object and sent after long pressing the push button attached to the input.	
Long push action min.	0.5 second 1 second 2 seconds 3 seconds 4 seconds 5 seconds 10 seconds
This parameter determines the minimum period for detecting a long push.	
Contact type	Normally open contact Normally closed contact
The contact type of the input attached to the channel is adjusted here. "Normally open contact": the contact of the input is active when closed, inactive when opened. "Normally closed contact": the contact of the input is active when opened, inactive when closed.	

Parameters	Setting
Add enable object	Yes / No
The parameter determines if the input can be blocked via an additional Enable object or not. If an input is blocked (Enable value = 0) the status changes at this input are not transmitted.	

8.1.2 Use Jointy

Dimming

Usage: Use jointly

G1+G2 : Main function: Dimming

G1 : Switching value on short push: On

G1 : Switching value on long push: On

G1 : Dimming value on long push: Dim+

G1 : Dimming value on release push: Stop

G1 : Long push button action min.: 2 seconds

G2 : Switching value on short push: Off

G2 : Switching value on long push: No reaction

G2 : Dimming value on long push: Dim-

G2 : Dimming value on release push: Stop

G2 : Long push button action min.: 2 seconds

Add Status Object: No

Contact type: Normally open contact

Add enable object: No

No.	Object name	Function	Size	Flags
2 (16, 30, 44, 58, 72, 86, 100)	Input G,(H)1 (3 → 7)+ G,(H)2 (4 → 8),	Switching	1.001 DPT_Switch	CWT
Switching telegrams are sent via the group address linked with this object.				
6 (20, 34, 48, 62, 76, 90, 104)	Input G,(H)1 (3 → 7)+ G,(H)2 (4 → 8)	Dimming	3.007 DPT_Control_Dimming	CT
Dimming telegrams are sent via the group address linked with this object.				
7 (21, 35, 49, 63, 77, 91, 105)	Input G,(H)1 (3 → 7)+ G,(H)2 (4 → 8)	Value Status	5.001 DPT_Scaling	CW
The dimming status telegrams are received from the dimming actuator via the group address linked with this object. This object is only visible when the parameter "Add status object" is set to "yes".				
4 (18, 32, 46, 60, 74, 88, 102)	Input G,(H)1 (3 → 7)+ G,(H)2 (4 → 8)	Enable	1.003 DPT_Enable	CW
Enable telegrams are received via the group address linked with this object. They are used to lock (disable) or unlock (enable) the corresponding input. They are only visible if "Add enable object" parameter value is set to yes.				

8. COMMUNICATION OBJECTS (CONTINUED)

Parameters	Setting
Xn - Switching value on short push	No reaction On Off Toggle
Here an adjustment is made to define which switching value is written into the storage cell of the communication object and sent after short pressing of the push button attached to the input. "No reaction" : A short push does not change the object value and also does not send a telegram. "On" : After short push, the switching value "ON" (binary value, "1") is transferred into the communication object and sent. "Off" : After short push, the switching value "OFF" (binary value "0") is transferred into the communication object and sent. "Toggle" : After short push, the switching value stored in the communication object is inverted and the new value is sent.	
Xn - Switching value on long push	No reaction On
Here an adjustment is made to define which switching value is written into the storage cell of the communication object and sent after long pressing of the push button attached to the input. "No reaction" : A long push does not change the object value and also does not send a telegram. "On" : A long push, the switching value "ON" (binary value, "1") is transferred into the communication object and sent.	
Xn - Dimming value on long push	Dim + Dim - No reaction
Here an adjustment is made to define which dimming value is written into the storage cell of the communication object and sent after long pressing of the push button attached to the input. "No reaction" : A long push does not change the object value and also does not send a telegram. "Dim +" : After short push, the dimming value "Increase 100%" is transferred into the communication object and sent. "Dim -" : After short push, the dimming value "Decrease 100%" is transferred into the communication object and sent.	
Xn - Dimming value on release push	No reaction Stop
Here an adjustment is made to define which dimming value is written into the storage cell of the communication object when releasing the push button after a long press. "No reaction" : A long push does not change the object value and also does not send a telegram. "Stop" : When the push button is released after a long push, the dimming value "Stop" is transferred into the communication object and sent.	
Xn - Long push button action min.	0.5 second 1 second 2 seconds 3 seconds 4 seconds 5 seconds 10 seconds
This parameter determines the minimum period for detecting a long push.	

Parameters	Setting
Xn+1 - Switching value on short push	No reaction On Off Toggle
Here an adjustment is made to define which switching value is written into the storage cell of the communication object and sent after short pressing of the push button attached to the input. "No reaction" : A short push does not change the object value and also does not send a telegram. "On" : After short push, the switching value "ON" (binary value, "1") is transferred into the communication object and sent. "Off" : After short push, the switching value "OFF" (binary value "0") is transferred into the communication object and sent. "Toggle" : After short push, the switching value stored in the communication object is inverted and the new value is sent.	
Xn+1 - Switching value on long push	No reaction On
Here an adjustment is made to define which switching value is written into the storage cell of the communication object and sent after long pressing of the push button attached to the input. "No reaction" : A long push does not change the object value and also does not send a telegram. "On" : A long push, the switching value "ON" (binary value, "1") is transferred into the communication object and sent.	
Xn+1 - Dimming value on long push	Dim + / Dim - No reaction
Here an adjustment is made to define which dimming value is written into the storage cell of the communication object and sent after long pressing of the push button attached to the input. "No reaction" : A long push does not change the object value and also does not send a telegram. "Dim +" : After short push, the dimming value "Increase 100%" is transferred into the communication object and sent. "Dim -" : After short push, the dimming value "Decrease 100%" is transferred into the communication object and sent.	
Xn+1 - Dimming value on release push	No reaction Stop
Here an adjustment is made to define which dimming value is written into the storage cell of the communication object and sent when releasing the push button after a long push. "No reaction" : A long push does not change the object value and also does not send a telegram. "Stop" : When the push button is released after a long push, the dimming value "Stop" is transferred into the communication object and sent.	
Xn+1 - Long push button action min.	0.5 second 1 second 2 seconds 3 seconds 4 seconds 5 seconds 10 seconds
This parameter determines the minimum period for detecting a long push.	
Add status object	Yes / No
The parameter determines if an additional communication object (status) shall be used to perform toggle functionality or other purposes.	
Contact type	Normally open contact Normally closed contact
The contact type of the input attached to the channel is adjusted here. "Normally open contact" : the contact of the input is active when closed, inactive when opened. "Normally closed contact" : the contact of the input is active when opened, inactive when closed.	
Add enable object	Yes / No
The parameter determines if the input can be blocked via an additional Enable object or not. If an input is blocked (Enable value = 0) the status changes at this input are not transmitted.	

8. COMMUNICATION OBJECTS (CONTINUED)

Shutter 2-input

No.	Object name	Function	Size	Flags
2 (16, 30, 44, 58, 72, 86, 100)	Input G,(H)1 (3 → 7)+ G,(H)2 (4 → 8)	Shutter Up/ Down	1.008 DPT_ UpDown	CWT
The movement commands Up/Down are sent via the address linked with this object in order to raise/lower the solar protection.				
8 (22, 36, 50, 64, 78, 92, 106)	Input G,(H)1 (3 → 7)+ G,(H)2 (4 → 8)	Shutter Stop - slats	1.009 DPT_ OpenClose	CWT
The commands "STOP" or "Slats OPEN/CLOSE" are sent via the group address linked with this object.				
4 (18, 32, 46, 60, 74, 88, 102)	Input G,(H)1 (3 → 7)+ G,(H)2 (4 → 8)	Enable	1.003 DPT_ Enable	CW
Enable telegrams are received via the group address linked with this object. They are used to lock (disable) or unlock (enable) the corresponding input. They are only visible if "Add status object" parameter value is set to yes.				

• Switch

Usage: Use jointly

G1+G2 : Main function: Shutter 2-inputs

Function: Switch

G1 : Sw value when contact is closed: Up

G1 : Sw value when contact is opened: Stop

G2 : Sw value when contact is closed: Down

G2 : Sw value when contact is opened: Stop

Contact type: Normally open contact

Add enable object: No

This function is used for 2 inputs with a switch to send a up,stop or down telegram : the contact is closed or opened, a telegram is sent.

Parameters	Setting
Xn - Switching value when contact is closed	No reaction Up Down
Here an adjustment is made to define which movement command is written into the storage cell of the communication object and sent after a rising edge. The rising edge corresponds to a change in the signal status at the input from logical "0" to "1". "No reaction": action does not change the object value and also does not send a telegram. "Up": when the contact is active, the command UP is transferred into the communication object and sent. "Down": when the contact is active, the command DOWN is transferred into the communication object and sent.	
Xn+1 - Switching value when contact is opened	No reaction Stop
Here an adjustment is made to define which switching movement command is written into the storage cell of the communication object and sent after a falling edge in the signal status at the channel (input). The falling edge corresponds to a change in the signal status at the input from logical "1" to "0". "No reaction": action does not change the object value and also does not send a telegram. "Stop": when the contact is inactive, the command stop is transferred into the communication object and sent.	

Parameters	Setting
Xn+1 - Switching value when contact is closed	No reaction Up Down
Here an adjustment is made to define which movement command is written into the storage cell of the communication object and sent after a rising edge. The rising edge corresponds to a change in the signal status at the input from logical "0" to "1". "No reaction": action does not change the object value and also does not send a telegram. "Up": when the contact is active, the command UP is transferred into the communication object and sent. "Down": when the contact is active, the command DOWN is transferred into the communication object and sent.	
Xn+1 - Switching value when contact is opened	No reaction Stop
Here an adjustment is made to define which switching movement command is written into the storage cell of the communication object and sent after a falling edge in the signal status at the channel (input). The falling edge corresponds to a change in the signal status at the input from logical "1" to "0". "No reaction": action does not change the object value and also does not send a telegram. "Stop": when the contact is inactive, the command stop is transferred into the communication object and sent	
Contact type	Normally open contact Normally closed contact
The contact type of the input attached to the channel is adjusted here. "Normally open contact": the contact of the input is active when closed, inactive when opened. "Normally closed contact": the contact of the input is active when opened, inactive when closed.	
Add enable object	Yes / No
The parameter determines if the input can be blocked via an additional Enable object or not. If an input is blocked (Enable value = 0) the status changes at this input are not transmitted.	

• Push

Usage: Use jointly

G1+G2 : Main function: Shutter 2-inputs

Function: Push

G1 : Short push reaction: Up + stop

G1 : Long push reaction: Open slats

G1 : Long push release: No reaction

G1 : Long push button action min.: 2 seconds

G2 : Short push reaction: Down + stop

G2 : Long push reaction: Close slats

G2 : Long push release: No reaction

G2 : Long push button action min.: 2 seconds

Contact type: Normally open contact

Add enable object: No

This function is used for 2 inputs with push button to send a up,stop or down telegram : the push is short or long, a telegram is sent.

8. COMMUNICATION OBJECTS (CONTINUED)

Parameters	Setting
Xn - Short push reaction	No reaction Up + stop Down + stop Stop Open slats Close slats
<p>Here an adjustment is made to define which movement command is written into the storage cell of the communication object and sent after short pressing of the push button attached to the input.</p> <p>"No reaction": action does not change the object value and also does not send a telegram.</p> <p>Up + stop: each short push transfers the following sequence command values into the communication object: Up, Stop, Up, Stop, etc.</p> <p>Down + stop: each short push transfers the following sequence command values into the communication object: Down, Stop, Down, Stop, etc.</p> <p>Stop: a short push transfers into the communication object the stop command value ("1" or "0").</p> <p>Open slats: a short push transfers into the communication object the stop (open slats) command value ("0").</p> <p>Close slats: a short push transfers into the communication object the stop (close slats) command value ("1").</p>	
Xn - Long push reaction	No reaction Up Down Stop Open slats Close slats
<p>Here an adjustment is made to define which movement command is written into the storage cell of the communication object and sent after long pressing of the push button attached to the input.</p> <p>"No reaction": action does not change the object value and also does not send a telegram.</p> <p>Up: a long push action transfers into the communication object the Up command (value "0")</p> <p>Down: a long push action send the Down command (value "1")</p> <p>Stop: a long push action sends the stop command (value "1" or "0")</p> <p>Open slats: a long push action transfers into the communication object the stop (open slats) command (value "0")</p> <p>Close slats: a long push action transfers into the communication object the stop (close slats) command (value "1")</p>	
Xn - Long push release	No reaction Stop
<p>Here an adjustment is made to define which value is written into the storage cell of the communication object and sent when releasing the push button after a long press.</p> <p>"No reaction": action does not change the object value and also does not send a telegram.</p> <p>Stop: the stop command (value "1" or "0") is transferred into the communication object and sent.</p>	
Xn - Long push action min.	0.5 second 1 second 2 seconds 3 seconds 4 seconds 5 seconds 10 seconds
<p>This parameter determines the minimum period for detecting a long push.</p>	

Parameters	Setting
Xn+1 - Short push reaction	No reaction Up + stop Down + stop Stop Open slats Close slats
<p>Here an adjustment is made to define which movement command is written into the storage cell of the communication object and sent after short pressing of the push button attached to the input.</p> <p>"No reaction": action does not change the object value and also does not send a telegram.</p> <p>Up + stop: each short push transfers the following sequence command values into the communication object: Up, Stop, Up, Stop, etc.</p> <p>Down + stop: each short push transfers the following sequence command values into the communication object.</p> <p>Stop: a short push transfers into the communication object the stop command value ("1" or "0").</p> <p>Open slats: a short push transfers into the communication object the stop (open slats) command value ("0").</p> <p>Close slats: a short push transfers into the communication object the stop (close slats) command value ("1").</p>	
Xn+1 - Long push reaction	No reaction Up Down Stop Open slats Close slats
<p>Here an adjustment is made to define which movement command is written into the storage cell of the communication object and sent after long pressing of the push button attached to the input.</p> <p>"No reaction": action does not change the object value and also does not send a telegram.</p> <p>Up: a long push action transfers into the communication object the Up command (value "0")</p> <p>Down: a long push action sends the Down command (value "1")</p> <p>Stop: a long push action sends the stop command (value "1" or "0")</p> <p>Open slats: a long push action transfers into the communication object the stop (open slats) command (value "0")</p> <p>Close slats: a long push action transfers into the communication object the stop (close slats) command (value "1")</p>	
Xn+1 - Long push release	No reaction / Stop
<p>Here an adjustment is made to define which value is written into the storage cell of the communication object and sent when releasing the push button after a long press.</p> <p>"No reaction": action does not change the object value and also does not send a telegram.</p> <p>Stop: the stop command (value "1" or "0") is transferred into the communication object and sent.</p>	

8. COMMUNICATION OBJECTS (CONTINUED)

Parameters	Setting
Xn+1 - Long push action min.	0.5 second 1 second 2 seconds 3 seconds 4 seconds 5 seconds 10 seconds
This parameter determines the minimum period for detecting a long push.	
Contact type	Normally open contact Normally closed contact
The contact type of the input attached to the channel is adjusted here. "Normally open contact": the contact of the input is active when closed, inactive when opened. "Normally closed contact": the contact of the input is active when opened, inactive when closed.	
Add enable object	Yes / No
The parameter determines if the input can be blocked via an additional Enable object or not. If an input is blocked (Enable value = 0) the status changes at this input are not transmitted.	

8.2 Outputs

8.2.1 Relays

Function On/Off

No.	Object name	Function	Size	Flags
114 (118, 122, 126, 130, 134, 138, 142, 146, 150, 154, 158, 162, 166, 170, 174)	Output Xn	Switching	1.001 DPT_Switch	CW
This object is used to receive the swithing telegrams that are transferred to the relay channel. Switching telegrams are sent via the group address linked with this object.				
115 (119, 123, 127, 131, 135, 139, 143, 147, 151, 155, 159, 163, 167, 171, 175)	Output Xn,	Switching Status	1.001 DPT_Switch	CRT
The current switching state of the channel is saved in the status object. It is automatically sent each time the object value changes.				
116 (120, 124, 128, 132, 136, 140, 144, 148, 152, 156, 160, 164, 168, 172, 176)	Output Xn	Enable	1.003 DPT_Enable	CW
Enable telegrams are received via the group address linked with this object. They are used to lock (disable) or unlock (enable) the corresponding input.				

No.	Object name	Function	Size	Flags
117 (121, 125, 129, 133, 137, 141, 145, 149, 153, 157, 161, 165, 169, 173, 177)	Output Xn	2bits Over-ride	2.001 DPT_Switch_Control	CW
Override telegrams are received via the group address linked with this object. Output Xn can be forcibly operated (e.g. by a higher-level control). The value of the communication object directly defines the forced position of the contact: 0 or 1 = The output is not forcibly operated (0 switched off, 1 switched on). 2 = The output is forcibly switched off. 3 = The output is forcibly switched on.				

Active F1 Yes

F1 : Name

F1 : Delay before Off Immediate

F1 : Delay before On Immediate

F1 : Active auto. off No

F1 : Invert relay polarity No

F1 : Invert "enable" logic No

Parameters	Setting
Active Xn	Yes / No
Xn : Delay before Off	Immediate , 500 ms, 1 second, 2 seconds, 5 seconds, 10 seconds, 30 seconds, 1 minute, 90 s, 2 min., 10 min., 15 min., 30 min., 45 min., 1 h, 90 min.
This parameter sets the wanted OFF delay time. A set OFF delay acts only on the object "Output Xn, Switch"	
Xn : Delay before On	Immediate , 500 ms, 1 second, 2 seconds, 5 seconds, 10 seconds, 30 seconds, 1 minute, 90 s, 2 min., 10 min., 15 min., 30 min., 45 min., 1 h, 90 min.
This parameter sets the wanted ON delay time. A set ON delay acts only on the object "Output Xn, Switch"	
Xn : Active auto. off	Yes / No
This parameter defines if the output is to be permanently switched on using the manual command and has to be switch off again using the manual command (No), or if it is switched on manually for a limited period and then automatically switched off (Yes).	
Xn : Auto. off delay	Immediate , 500 ms, 1 second, 2 seconds, 5 seconds, 10 seconds, 30 seconds, 1 minute, 90 s, 2 min., 10 min., 15 min., 30 min., 45 min., 1 h, 90 min.
This parameter determines the delay before automatic switch-off.	
Xn : Invert relay polarity	Yes / No
The polarity type of the output attached to the channel is adjusted here. "No": the contact of the output is close when active, open when inactive "Yes": the contact of the output is open when active, closed when inactive	

8. COMMUNICATION OBJECTS (CONTINUED)

Parameters	Setting
Xn : Invert enable logic	Yes / No
The Enable logic of the output attached to the channel is adjusted here. "No": the contact of the output is Disable when "Output Xn, Enable" object value is 0. "Yes": the contact of the output is Disable when "Output Xn, Enable" object value is 1.	

8.2.2 Shutter (for Ports A and B only)

No.	Object name	Function	Size	Flags
114,122	Outputs A (B)	Shutter Up/Down	1.008 DPT_UpDown	CW

The Up/Down movement for the corresponding channel is initiated via these objects. The shutter is raised on receipt of a logical 0 and lowered on receipt of a logical 1. The drive mechanism remains switched on until either a stop command is received

115,123	Outputs A (B)	Open/Close Slats Shutter Stop	1.009 DPT_OpenClose	CW
---------	---------------	----------------------------------	---------------------	----

Via these objects, the movement of a blind/shutter is stopped regardless of whether the telegram contains a logical 0 or a logical 1. If the output is configured as "Venetian blind" and the blind is stationary, the slats are opened by one step on receipt of a logical 0 and closed by one step on receipt of a logical 1. If the output is configured as "Roller shutter" and a stop command is received when the roller shutter is stationary, the command is ignored.

117,125	Outputs A (B)	Shutter Alarm	1.005 DPT_Alarm	CW
---------	---------------	---------------	-----------------	----

This object can be linked with an alarm signal from a wind, rain or ice detector, which sends a logical 0 in the idle state and a logical 1 in the event of an alarm.

116,124	Outputs A (B)	Shutter Enable	1.003 DPT_Enable	CW
---------	---------------	----------------	------------------	----

Enable telegrams are received via the group address linked with this object. They are used to lock (disable) or unlock (enable) the corresponding input.

In venetian blind use you have the parameters for slat control

A1 + A2 Usage	Venetian blind
Up to Down time (base 1s)	30
Slats time (base 100ms)	3
Behaviour on alarm	No action
Invert relay polarity	No
Invert "enable" logic	No

A1 + A2 Usage	Roller shutter
Up to Down time (base 1s)	30
Behaviour on alarm	No action
Invert relay polarity	No
Invert "enable" logic	No

Parameters	Setting
Xn+(n+1) Usage	Use separately(*) Venetian blind Roller shutter Exclusive function
Slat time (base 100ms)	3 (0 → 255)
Only available if "Xn+(n+1) Usage" is set to "Venetian blind"	

Parameters	Setting
Up to Down time (base 1s)	30 (0 → 255)
Only available if "Xn+(n+1) Usage" is set to "Venetian blind" or "Roller shutter"	
Behaviour on alarm	No action Move up Move down

Only available if "Xn+(n+1) Usage" is set to "Venetian blind" or "Roller shutter"

Invert relay polarity	Yes / No
------------------------------	----------

Allows to invert the move up/down command.
 "No": X1 is move up, X2 move down
 "Yes": X1 is move down, X2 is move up

Invert Enable logic	Yes / No
----------------------------	----------

The Enable logic of the output attached to the channel is adjusted here.
 "No": the contact of the output is Disable when "Output Xn, Enable" object value is 0.
 "Yes": the contact of the output is Disable when "Output Xn, Enable" object value is 1.

(*): See the previous parameters description and communication object description table

8.2.3 Exclusive function (Ports A and B only)

This functionality is used to perform logical XOR functions between two relays on the same port.

A1 + A2 Usage	Exclusive function
Invert relay polarity	No

No.	Object name	Function	Size	Flags
115 (122)	Outputs A (B)	A2 on & A1 off Off (B2 on & B1 off Off)	1.002 DPT_ Bool	CW

1 : Activates A2, Deactivates A1
 0 : Deactivates A1 and A2

114 (123)	Outputs A (B)	A1 on & A2 off Off (B1 on & B2 off Off)	1.002 DPT_ Bool	CW
-----------	---------------	---	-----------------	----

1 : Activates A1, Deactivates A2
 0 : Deactivates A1 and A2

121 (129)	Outputs A (B)	A2 Status (B2 Status)	1.002 DPT_ Bool	CRT
-----------	---------------	-----------------------	-----------------	-----

1 : A2 (B2) is activated
 0 : A2 (B2) is deactivated

117 (125)	Outputs A (B)	A1 Status (B1 Status)	1.002 DPT_ Bool	CRT
-----------	---------------	-----------------------	-----------------	-----

1 : A1 (B1) is activated
 0 : A1 (B1) is deactivated

Parameters	Setting
Xn, Invert relay polarity	Yes / No
Allows to invert the logic of the exclusive function	

8. COMMUNICATION OBJECTS (CONTINUED)

8.2.4 DALI

No.	Object name	Function	Size	Flags
178	DALI	Switching	1.001 DPT_Switch	CW
This object is used to receive the switching telegrams that are transferred to the DALI bus in broadcast mode. Switching telegrams are sent via the group address linked with this object.				
179	DALI	Switching Status	1.001 DPT_Switch	CRT
The current switching state of the channel is saved in the status object. It is automatically sent each time the object value changes.				
180	DALI	Level	5.001 DPT_Scaling	CW
This object is used to receive the level value telegrams that are transferred to the DALI bus in broadcast mode. Level value telegrams are sent via the group address linked with this object.				
181	DALI	Level Status	5.001 DPT_Scaling	CRT
The current level state of the channel is saved in the status object. It is automatically sent each time the object value changes.				
184	DALI	Dimming	3.007 DPT_Control_Dimming	CW
Dimming control telegrams are received via the group address linked with this object.				
182	DALI	Enable	1.003 DPT_Enable	CW
Enable telegrams are received via the group address linked with this object. They are used to lock (disable) or unlock (enable) the corresponding input.				
183	DALI	2bits Override	2.001 DPT_Switch_Control	CW
Override telegrams are received via the group address linked with this object. Output Xn can be forcibly operated (e.g. by a higher-level control). The value of the communication object directly defines the forced position of the contact: 0 or 1 = The output is not forcibly operated. (0 switched off, 1 switched on) 2 = The output is forcibly switched off. 3 = The output is forcibly switched on.				

Active DALI	Yes
Min. Level (%)	5
Max. Level (%)	100
Fade rate Level (%/s.)	10
Fade rate Dim (%/s.)	10
Delay before Off	Immediate
Delay before On	Immediate
Invert "enable" logic	No
Invert relay polarity	No

Parameters	Setting
Use DALI	Yes / No
Yes: communication objects and parameters are visible. No: communication objects and parameters are hidden.	
Min. Level (%)	0 → 100 (default 5%)
This parameter is used to set the minimum level that shall be used for the dimmer. Attention, this value can be overridden by the dali ballast physical minimum level.	
Max. Level (%)	0 → 100 (default 100%)
This parameter is used to set the maximum level that shall be used for the dimmer.	
Fade rate level (%/s)	0 → 100 (default 10%)
This parameter is used to set the fade rate that shall be used with the Level and switching communication objects.	
Fade rate Dim (%/s)	0 → 100 (default 10%)
This parameter is used to set the fade rate that shall be used with the dimming communication object.	
Delay before Off	Immediate, 500 ms, 1 second, 2 seconds, 5 seconds, 10 seconds, 30 seconds, 1 minute, 90 s., 2 min., 10 min., 15 min., 30 min., 45 min., 1 h, 90 min.
This parameter sets the wanted OFF delay time. A set OFF delay acts only on the object "Output Xn, Switch".	
TimeBeforeOn	No reaction / Stop
This parameter sets the wanted ON delay time. A set ON delay acts only on the object "Output Xn, Switch".	
Xn, Invert Enable logic	Yes / No
The Enable logic of the output attached to the channel is adjusted here. "No": the contact of the output is Disable when "DALI, Enable" object value is 0. "Yes": the contact of the output is Disable when "DALI, Enable" object value is 1.	
Xn, Invert relay polarity	Yes / No
The polarity type of the output attached to the channel is adjusted here. "No": the contact of the output is closed when active, open when inactive. "Yes": the contact of the output is open when active, close when inactive.	

8.3 MODE

Four modes are applicable. Each mode determines if an output should be available or not. An additional parameter allows to determine the action to do when the desired mode is launched. If an output is active, objects "Scene", "Override", "Enable/Disable", "On/Off" are usable. If an output is inactive, the output cannot be managed by any object as long as the current mode is active. If the additional parameter "Authorize a last Manual Off" is set to "yes" it is possible to switch off the output before the output locks. The additional parameter "Authorize a last Manual Off" is only available if output is set as inactive in the current mode and the parameter "Action on change" is set to "none" or "On" or "Enable+on". Mode management is not available for Block A and B when they are configured as "Roller shutter", "Venetian blind", "Exclusive function".

8. COMMUNICATION OBJECTS (CONTINUED)

C1 - Mode 0 - System -----

C1 - Active

C1 - Action on change

C1 - Mode 1 -----

C1 - Active

C1 - Action on change

C1 - Authorize a last Manual Off

C1 - Mode 2 -----

C1 - Active

C1 - Action on change

C1 - Mode 3 -----

C1 - Active

C1 - Action on change

C1 - Authorize a last Manual Off

Parameters	Setting
Mode	Mode 1 Mode 2 Mode 3 Mode 0 (System)
This is a virtual parameter in order to configure each mode.	
Xn, Active	Yes / No
Here it is possible to do an adjustment to make the output available or not within the 4 different modes. This is a very high priority, "Override" actions and "Enable" actions will have no effect on the output if "Xn Active" is set to "No". With "Mode 0 (System)", this parameter has a ReadOnly permission and locked to "Yes".	
Xn, Action on change	None On Off Enable + On Enable + Off On + Disable Off + Disable
Here it is possible to make an adjustment to set an automatic order command when mode under configuration is active.	
Xn, Authorize a last manual off	Yes / No
Here it is possible to make an adjustment to allow a last OFF order command on Xn when "Xn, Active" parameter is set to "No" (before output becomes unavailable). This parameter is visible only if "Xn, Active" is set to "No" and "Xn Action on change" is set to "None"/"On" or "Enable+On".	

No.	Object name	Function	Size	Flags
198	Mode_Sytem	Mode_Sytem	1.010 DPT_Start	CRW
1 : Enables System mode, disables all other modes 0 : No reaction				
199	Mode_1	Mode_1	1.010 DPT_Start	CRW
1 : Enables mode 1, disables all other modes 0 : No reaction				
200	Mode_2	Mode_2	1.010 DPT_Start	CRW
1 : Enables mode 2, disables all other modes 0 : No reaction				
201	Mode_3	Mode_3	1.010 DPT_Start	CRW
1 : Enables mode 3, disables all other modes 0 : No reaction				

Parameters	Setting
Xn, Invert relay polarity	Yes / No
Allows to invert the move DND/MUR command.	

8.4 Power Measure Management

No.	Object name	Function	Size	Flags
185 (186, 187, 188)	Outputs C (D, E, F)	Energy	13.010 DPT_ActiveEnergy	CR
The value saved into this communication object represents the measured active energy.				
189 (190, 191, 192)	Outputs C (D, E, F)	Energy Reset	1.010 DPT_Start	CW
Start: resets the active energy counter Stop: No reaction				
193 (194, 195, 196)	Outputs C (D, E, F)	Power measure	14.56 DPT_Value_Power	CR
The value of this communication object represents the measured electrical power. If the object communication "write" flag is set, the current value is automatically sent each time the object value changes.				

Active power measure

Parameters	Setting
Active power measure	Yes No
This parameter is used to hide or display the communication objects relating to power measure management.	

8. COMMUNICATION OBJECTS (CONTINUED)

8.5 Scenes

No.	Object name	Function	Size	Flags
1	Input Scene	Recall scene	17.001 DPT_Scene- Number	CW

Scenes telegrams are received via the group address linked with this object.
The scene value affects all outputs using this scene number.

INSTANCE 1 :

C1 : Scenario number (0=not used)

C1 : Binary value

C1 : Delay

C2 : Scenario number (0=not used)

C2 : Binary value

C2 : Delay

C3 : Scenario number (0=not used)

C3 : Binary value

C3 : Delay

C4 : Scenario number (0=not used)

C4 : Binary value

C4 : Delay

Each output channel can be assigned to 5 different instances.
Each output channel can be assigned to 5 different scenario instances.
For Outputs A1, A2, B1, B2, those parameters are only available when outputs are configured as switch "use separately".

Parameters	Setting
Xn, Scenario Number	0 → 64
0 : No scenario	
Xn, Scenario Order	Off On Off + Disable On + Disable Enable + Off Enable + On Enable Disable
Here it is possible to make an adjustment to define the order action that should be executed on the output when the corresponding scene number is received.	
Xn, Delay	Immediate , 500 ms, 1 second, 2 seconds, 5 seconds, 10 seconds, 30 seconds, 1 minute, 90 sec., 2 min., 10 min., 15 min., 30 min., 45 min., 1 h, 90 min.
Here it is possible to make an adjustment to define a delay before executing the order action on the output when the corresponding scene number is received.	

For Outputs A and B, those parameters are only available when they are configured as "Roller shutter" or "Venetian blinds".

Parameters	Setting
Xn+(n+1), Scenario Number	0 → 64
0 : No scenario	
Xn+(n+1), Scenario Order	Up Down Up + Disable On + Disable Enable + Up Enable + Down Enable Disable

Here it is possible to make an adjustment to define the order action that should be executed on the output when the corresponding scene number is received.

Xn+(n+1), Delay	Immediate , 500 ms, 1 second, 2 seconds, 5 seconds, 10 seconds, 30 seconds, 1 minute, 90 s., 2 min., 10 min., 15 min., 30 min., 45 min., 1 h, 90 min.
------------------------	--

Here it is possible to make an adjustment to define a delay before executing exclusive function the order action on the output when the corresponding scene number is received.

For Outputs A and B, those parameters are only available when they are configured as "Exclusive function".

Parameters	Setting
Xn+(n+1), Scenario Number	0 → 64
0 : No scenario	
Xn+(n+1), Scenario Order	Do Not disturb Make Up Room Stop

Here it is possible to make an adjustment to define the order action that should be executed on the output when the corresponding scene number is received.

Xn+(n+1), Delay	Immediate , 500 ms, 1 second, 2 seconds, 5 seconds, 10 seconds, 30 seconds, 1 minute, 90 s., 2 min., 10 min., 15 min., 30 min., 45 min., 1 h, 90 min.
------------------------	--

Here it is possible to make an adjustment to define a delay before executing the order action on the output when the corresponding scene number is received.

8.6 Program Functions

3 program functions are available.

Each program function allows to generate up to 5 different commands (fully configurable) triggered by one input condition (fully configurable).

No.	Object name	Function	Size	Flags
214 (220, 226)	Program Fn	Program Fn Input 1bit	1.002 DPT_ Bool	CRW
		Program Fn Input 2bits	2.002 DPT_ Bool_Control	
		Program Fn Input 4bits	3.007 DPT_ Control_Dim- ming	
		Program Fn Input 1bytes	5.010 DPT_ Value_1_ Ucount	
		Program Fn Input 2bytes	7.001 DPT_ Value_2_ Ucount	
		Program Fn Input 4bytes	12.001 DPT_ Value_4_ Ucount	

This object is used to trigger the program function.
Depending on the "Input Size" parameter, this communication can have different datapoint types.

8. COMMUNICATION OBJECTS (CONTINUED)

No.	Object name	Function	Size	Flags
215 (221, 227)	Program Fn	Program Fn Output 1 1bit	1.002 DPT_ Bool	CT
		Program Fn Output 1 2bits	2.002 DPT_ Bool_Control	
		Program Fn Output 1 4bits	3.007 DPT_ Control_Dimming	
		Program Fn Output 1 1bytes	5.010 DPT_ Value_1_ Ucount	
		Program Fn Output 1 2bytes	7.001 DPT_ Value_2_ Ucount	
		Program Fn Output 1 4bytes	12.001 DPT_ Value_4_ Ucount	

The Program function Output 1 value is sent via the address linked with this object when the program is triggered.

216 (222, 228)	Program Fn	Program Fn Output 2 1bit	1.002 DPT_ Bool	CT
		Program Fn Output 2 2bits	2.002 DPT_ Bool_Control	
		Program Fn Output 2 4bits	3.007 DPT_ Control_Dimming	
		Program Fn Output 2 1bytes	5.010 DPT_ Value_1_ Ucount	
		Program Fn Output 2 2bytes	7.001 DPT_ Value_2_ Ucount	
		Program Fn Output 2 4bytes	12.001 DPT_ Value_4_ Ucount	

The Program function Output 2 value is sent via the address linked with this object when the program is triggered.

217 (223, 229)	Program Fn	Program Fn Output 3 1bit	1.002 DPT_ Bool	CT
		Program Fn Output 3 2bits	2.002 DPT_ Bool_Control	
		Program Fn Output 3 4bits	3.007 DPT_ Control_Dimming	
		Program Fn Output 3 1bytes	5.010 DPT_ Value_1_ Ucount	
		Program Fn Output 3 2bytes	7.001 DPT_ Value_2_ Ucount	
		Program Fn Output 3 4bytes	12.001 DPT_ Value_4_ Ucount	

The Program function Output 3 value is sent via the address linked with this object when the program is triggered.

No.	Object name	Function	Size	Flags
218 (224, 230)	Program Fn	Program Fn Output 4 1bit	1.002 DPT_ Bool	CT
		Program Fn Output 4 2bits	2.002 DPT_ Bool_Control	
		Program Fn Output 4 4bits	3.007 DPT_ Control_Dimming	
		Program Fn Output 4 1bytes	5.010 DPT_ Value_1_ Ucount	
		Program Fn Output 4 2bytes	7.001 DPT_ Value_2_ Ucount	
		Program Fn Output 4 4bytes	12.001 DPT_ Value_4_ Ucount	

The Program function Output 4 value is sent via the address linked with this object when the program is triggered.

219 (225, 231)	Program Fn	Program Fn Output 5 1bit	1.002 DPT_ Bool	CT
		Program Fn Output 5 2bits	2.002 DPT_ Bool_Control	
		Program Fn Output 5 4bits	3.007 DPT_ Control_Dimming	
		Program Fn Output 5 1bytes	5.010 DPT_ Value_1_ Ucount	
		Program Fn Output 5 2bytes	7.001 DPT_ Value_2_ Ucount	
		Program Fn Output 5 4bytes	12.001 DPT_ Value_4_ Ucount	

The Program function Output 5 value is sent via the address linked with this object when the program is triggered.

Parameters	Setting
Active Program X	Yes / No
This is a parameter that indicates if Program X should be used or not. If not, no communication object parameters will be visible.	
Program X name	string
This is a parameter to name the program. There is no influence on the program behavior.	
Name Px_input	string
This is a parameter to name the input function.	
Input Size	1 bit 2 bits 4 bits 1 Byte 2 Bytes 4 Bytes
Here it is possible to make an adjustment to set the datapoint size of the "Program Fn Input XXX" communication object.	

8. COMMUNICATION OBJECTS (CONTINUED)

Parameters	Setting	
Value Type	"Input Size" value	Possible setting values
	1 bit	Value
		On/Off
		Enable/Disable
		Up/Down
	2 bits	Value
		Control Value
	4 bits	Value
		Dimming
	1 Byte	Non-scaled value
		Scaled value
		Scene
	2 Bytes	Unsigned value
Floating value		
4 Bytes	Unsigned value	
	Floating value	

Here it is possible to make an adjustment to set the datapoint type of the comparison value.

Value	1 bit Value	0, 1	
	1 bit On/Off	On, Off	
	1 bit Enable/Disable	Enable / Disable	
	1 bit Up/Down	Up / Down	
	2 bits Value	0, 1, 2, 3	
		Priority High / On	
		Priority High / Off	
	2 bits Control Value	Priority Low / On	
		Priority Low / Off	
		Priority Low / Off	
	4 bits Value	0 → 15	
	4 bits Dimming	Up 100%, Up 50%, Up 25%, Up 12%, Up 6%, Up 3%, Down 1%, Stop, Stop, Down 1%, Down 3%, Down 6%, Down 12%, Down 25%, Down 50%	
		1 Byte Non-scaled value	0 → 255
		1 Byte Scaled value	0 → 100%
		1 Byte Scene	1 → 64
		2 Bytes Unsigned value	0 → 65535
	2 Bytes Floating value	0 → 65535	
4 Bytes Unsigned value	0 → 4294967295		
4 Bytes Floating value	0 → 4294967295		

Here it is possible to make an adjustment to set the value that should be compared to Program Fn Input XXX value. If equal, then the program sequence starts.

Name Px_ Output 1 (2 → 5)	string
----------------------------------	--------

This is a parameter to name the output X function.

Output 1 (2 → 5) Size	1 bit
	2 bits
	4 bits
	1 Byte
	2 Bytes
4 Bytes	

Here it is possible to make an adjustment to set the datapoint size of the "Program Fn Output Y XXX" communication object.

Parameters	Setting	
Output 1 (2 → 5) Value Type	"Input Size" value	Possible setting values
	1 bit	Value
		On/Off
		Enable/Disable
		Up/Down
	2 bits	Value
		Control Value
	4 bits	Value
		Dimming
	1 Byte	Non-scaled value
		Scaled value
		Scene
	2 Bytes	Unsigned value
Floating value		
4 Bytes	Unsigned value	
	Floating value	

Here it is possible to make an adjustment to set the datapoint type of the value that should be sent on the bus via the Program Fn Output Y XXX communication object.

Output 1 (2 → 5) Value	1 bit Value	0, 1	
	1 bit On/Off	On, Off	
	1 bit Enable/Disable	Enable / Disable	
	1 bit Up/Down	Up / Down	
	2 bits Value	0, 1, 2, 3	
		Priority High / On	
		Priority High / Off	
	2 bits Control Value	Priority Low / On	
		Priority Low / Off	
		Priority Low / Off	
	4 bits Value	0 → 15	
	4 bits Dimming	Up 100%, Up 50%, Up 25%, Up 12%, Up 6%, Up 3%, Up 1%, Stop, Stop, Down 1%, Down 3%, Down 6%, Down 12%, Down 25%, Down 50%	
		1 Byte Non-scaled value	0 → 255
		1 Byte Scaled value	0 → 100%
		1 Byte Scene	1 → 64
		2 Bytes Unsigned value	0 → 65535
	2 Bytes Floating value	0 → 65535	
4 Bytes Unsigned value	0 → 4294967295		
4 Bytes Floating value	0 → 4294967295		

Here it is possible to make an adjustment to set the value that should be sent on the bus via the Program Fn Output Y XXX communication object.

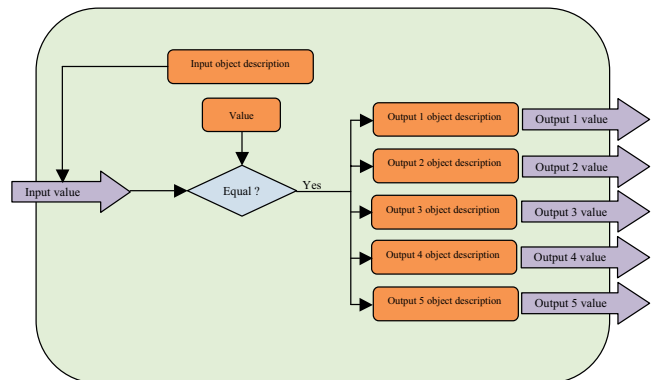

8. COMMUNICATION OBJECTS (CONTINUED)

8.7 Logical functions

3 logical functions are available.

A logical function consists in generating an output command resulting from a logic operation comprising up to 3 input conditions.

Each input (fully configurable) is compared with a preset value depending of the communication objects size selected. The element of comparison between the preset value and the value received into the input communication object is also configurable (equal, different, higher, lower, etc.).

The logical result of each comparison (true or false) is then operated by up to 2 operators (depending on whether different inputs are used or not) in order to generate a logic operation result. This result is used to trigger the output telegram (fully configurable).

The output telegram value can be the logic operation result or a preset value (the preset value size depends on the chosen output communication object size). Also, there is a condition (configurable) that triggers the output telegram sending (see parameter "Output SendCondition").

No.	Object name	Function	Size	Flags
202 (206, 210)	Logic Fn	Logic Fn Input 1 1bit	1.002 DPT_ Bool	CRW
		Logic Fn Input 1 2bits	2.002 DPT_ Bool_Control	
		Logic Fn Input 1 4bits	3.007 DPT_ Control_Dim- ming	
		Logic Fn Input 1 1bytes	5.010 DPT_ Value_1_ Ucount	
		Logic Fn Input 1 2bytes	7.001 DPT_ Value_2_ Ucount	
		Logic Fn Input 1 4bytes	12.001 DPT_ Value_4_ Ucount	

This object is used, as an event, to trigger the logical function. Depending on the "Input 1: Object size" parameter, this communication can have different datapoint type.

No.	Object name	Function	Size	Flags
203 (207, 211)	Logic Fn	Logic Fn Input 2 1bit	1.002 DPT_ Bool	CRW
		Logic Fn Input 3 2bits	2.002 DPT_ Bool_Control	
		Logic Fn Input 3 4bits	3.007 DPT_ Control_Dim- ming	
		Logic Fn Input 3 1bytes	5.010 DPT_ Value_1_ Ucount	
		Logic Fn Input 3 2bytes	7.001 DPT_ Value_2_ Ucount	
		Logic Fn Input 3 4bytes	12.001 DPT_ Value_4_ Ucount	

This object is used, as event, to trigger the logical function. Depending of "Input 1: Object size" parameter, this communication can have different datapoint type.

No.	Object name	Function	Size	Flags
204 (208, 212)	Logic Fn	Logic Fn Input 3 1bit	1.002 DPT_ Bool	CRW
		Logic Fn Input 3 2bits	2.002 DPT_ Bool_Control	
		Logic Fn Input 3 4bits	3.007 DPT_ Control_Dim- ming	
		Logic Fn Input 3 1bytes	5.010 DPT_ Value_1_ Ucount	
		Logic Fn Input 3 2bytes	7.001 DPT_ Value_2_ Ucount	
		Logic Fn Input 3 4bytes	12.001 DPT_ Value_4_ Ucount	

This object is used, as an event, to trigger the logical function. Depending on the "Input 1: Object size" parameter, this communication can have different datapoint type.

No.	Object name	Function	Size	Flags
205 (209, 213)	Logic Fn	Logic Fn Output 1bit	1.002 DPT_ Bool	CT
		Logic Fn Out- put 2bits	2.002 DPT_ Bool_Control	
		Logic Fn Out- put 4bits	3.007 DPT_ Control_Dim- ming	
		Logic Fn Out- put 1bytes	5.010 DPT_ Value_1_ Ucount	
		Logic Fn Out- put 2bytes	7.001 DPT_ Value_2_ Ucount	
		Logic Fn Out- put 4bytes	12.001 DPT_ Value_4_ Ucount	

The Logic Fn Output xx object value is sent via the address linked with this object depending on the logical function configuration.

Active Logic Function 1

Input 1 : Object size

Input 1 : Type of value

Input 1 : Value

Comparator 1

Operator 1

Input 2 : Object size

Input 2 : Type of value

Input 2 : Value

Comparator 2

Operator 2

Input 3 : Object size

Input 3 : Type of value

Input 3 : Value

Comparator 3

8. COMMUNICATION OBJECTS (CONTINUED)

Parameters	Setting		
Active Logic function X	Yes / No		
This is a parameter that indicates if Logic function X should be used or not. If not, no communication object parameters will be visible.			
Input 1 : Object size	1 bit/2 bits/4 bits/1 Byte/2 Bytes/4 Bytes		
Here it is possible to make an adjustment to set the datapoint size of the "Logic Fn Input XXX" communication object.			
Input 1 : Type of value	"Input Size" value	Possible setting values	
	1 bit	Value On/Off Enable/Disable Up/Down	
	2 bits	Value Control Value	
	4 bits	Value Dimming	
	1 Byte	Non-scaled value Scaled value Scene	
	2 Bytes	Unsigned value Floating value	
	4 Bytes	Unsigned value Floating value	
	Here it is possible to make an adjustment to set the datapoint type of the comparison value.		
	Input 1 : value	1 bit Value	0, 1
		1 bit On/Off	On, Off
		1 bit Enable/Disable	Enable / Disable
		1 bit Up/Down	Up / Down
2 bits Value		0, 1, 2, 3	
2 bits Control Value		Priority High / On Priority High / Off Priority Low / On Priority Low / Off	
4 bits Value		0 → 15	
4 bits Dimming		Up 100%, Up 50%, Up 25%, Up 12%, Up 6%, Up 3%, Up 1%, Stop, Stop, Down 1%, Down 3%, Down 6%, Down 12%, Down 25%, Down 50%	
1 Byte Non-scaled value		0 → 255	
1 Byte Scaled value		0 → 100%	
1 Byte Scene		1 → 64	
2 Bytes Unsigned value		0 → 65535	
2 Bytes Floating value*		0 → 65535	
4 Bytes Unsigned value	0 → 4294967295		
4 Bytes Unsigned value	0 → 4294967295		
Here it is possible to make an adjustment to set the value that should be compared to Logic Fn Input 1 XXX value (received from the bus). *: Only the positive integer part is used.			
Comparator 1	= (equal to) != (not equal to) < (lower than) <= (lower than or equal to) > (higher than) >= (higher than or equal to)		
This is an adjustment to choose which comparator should be used to compare Value 1 parameter and the value received from the bus (Logic Fn Input 1 XXX). Attention : Due to errors of precision, it's strongly recommended not to use the "=" and "!=" comparator with floating value or scaled value.			

Parameters	Setting
Operator 1	None AND OR XOR NAND NOR
Operator 1	
Input 2 : Object size	See "Input 1 : Object size" parameter description
Here it is possible to make an adjustment to set the datapoint size of the "Logic Fn Input XXX" communication object.	
Input 2 : Type of value	See "Input 1 : Type of value" parameter description
Here it is possible to make an adjustment to set the datapoint type of the compared value.	
Input 2 : value	See "Input 1 : value" parameter description
Here it is possible to make an adjustment to set the value that should be compared to Logic Fn Input 2 XXX value (received from the bus).	
Comparator 2	= (equal to) != (not equal to) < (lower than) <= (lower than or equal to) > (higher than) >= (higher than or equal to)
Here it is possible to make an adjustment to choose which comparator should be used to compare Value 2 parameter and the value received from the bus (Logic Fn Input 2 XXX). Attention : Due to errors of precision, it's strongly recommended not to use the "=" and "!=" comparator with floating value or scaled value.	
Operator 2	None AND OR XOR NAND NOR
Operator 2	
Input 3 : Object size	See "Input 1 : Object size" parameter description
Here it is possible to make an adjustment to set the datapoint size of the "Logic Fn Input XXX" communication object.	
Input 3 : Type of value	See "Input 1 : Type of value" parameter description
Here it is possible to make an adjustment to set the datapoint type of the compared value.	
Input 3 : value	See "Input 1 : value" parameter description
Here it is possible to make an adjustment to set the value that should be compared to Logic Fn Input 3 XXX value (received from the bus).	
Comparator 3	= (equal to) != (not equal to) < (lower than) <= (lower than or equal to) > (higher than) >= (higher than or equal to)
Comparator 3	
Output : Type of result	Logic result
Output : Send condition	Result change
Output : Type of result	Fixed value
Output : Send condition	Input 1 event
Output : Object size	1 Byte
Output : Type of value	Scene
Output : Value	5

8. COMMUNICATION OBJECTS (CONTINUED)

Parameters	Setting
Output Result	Logic Result Fixed value
This is a parameter that determines which kind of value should be sent into Logic Fn Output object. It can be the logic operation result or a preset value (fixed value).	
Output Send-Condition	Result change Result is true Result is false Input 1 event Input 2 event Input 3 event Input 1 or 2 or 3 event
Here it is possible to make a parameter that determines the trigger condition of the Logic Fn Output object telegram sending.	
Input 1 Size	1 bit 2 bits 4 bits 1 Byte 2 Bytes 4 Bytes
Here it is possible to make an adjustment to set the datapoint size of the "Logic Fn Output" communication object.	
Value 1 Type	"Input Size" value
1 bit	Value On/Off Enable/Disable Up/Down
2 bits	Value Control Value
4 bits	Value Dimming
1 Byte	Non-scaled value Scaled value Scene
2 Bytes	Unsigned value Floating value
4 Bytes	Unsigned value Floating value
Here it is possible to make an adjustment to set the datapoint type of the comparison element.	
Value 1	1 bit Value 0, 1
1 bit On/Off	On, Off
1 bit Enable/Disable	Enable / Disable
1 bit Up/Down	Up / Down
2 bits Value	0, 1, 2, 3
2 bits Control Value	Priority High / On Priority High / Off Priority Low / On Priority Low / Off
4 bits Value	0 → 15
4 bits Dimming	Up 100%, Up 50%, Up 25%, Up 12%, Up 6%, Up 3%, Up 1%, Stop, Stop, Down 1%, Down 3%, Down 6%, Down 12%, Down 25%, Down 50%
1 Byte Non-scaled value	0 → 255
1 Byte Scaled value	0 → 100%
1 Byte Scene	1 → 64
2 Bytes Unsigned value	0 → 65535
2 Bytes Floating value	0 → 65535
4 Bytes Unsigned value	0 → 4294967295
4 Bytes Floating value	0 → 4294967295
This is an adjustment to set the value that should be compared to Logic Fn Input XXX value.	

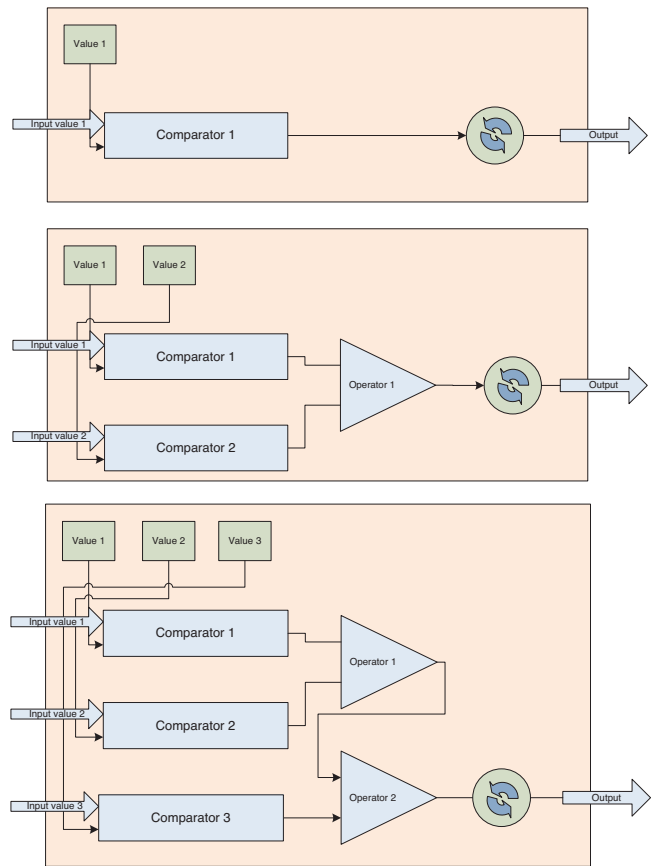

Synoptic: output behaviours

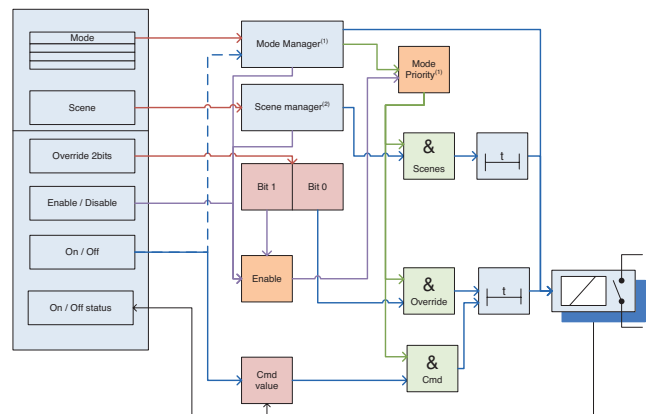

(1) Mode manager

Four modes are applicable. Each mode determines if the output should be available or not (very high priority) If the output is inactive, the output cannot be managed by any object as long as the current mode is active, otherwise, objects "Scene", "Override", "Enable/Disable", "On/Off" are usable.

It's possible to determine the action to do when the desired mode is launched.

(2) Scene manager

Each output can be assigned to 5 instances of scenes. An instance scene is defined by a scene number and a value preset. If the scene number is set to the value "0", the scene instance is not used.

Scenes action can be executed after a time delay. This time delay is independent and overrides the outputs' delay parameters "time before off" and "time before on".

8. COMMUNICATION OBJECTS (CONTINUED)

Output delay parameters

a) Without any delay

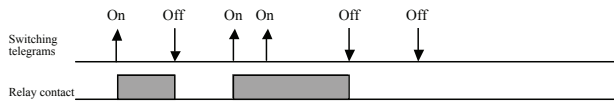

b) Delay before ON

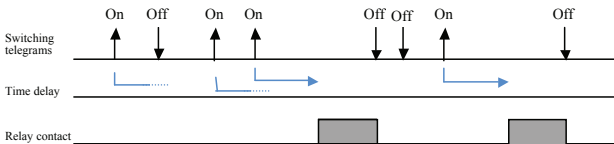

c) Delay before OFF

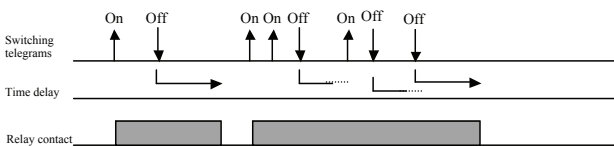

d) Delay before OFF + delay before ON

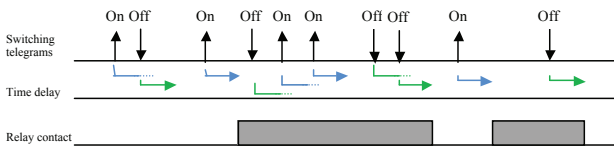

e) Auto Switch OFF

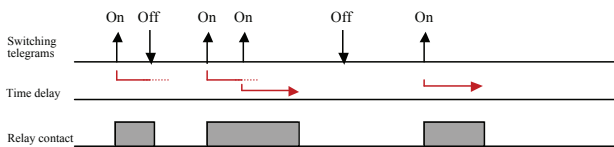

f) Delay before ON + Auto Switch OFF

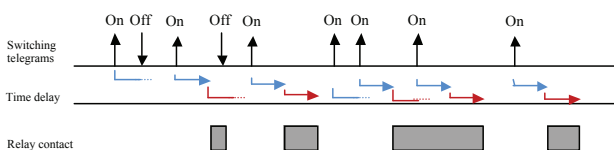

g) Delay before OFF + Auto Switch OFF

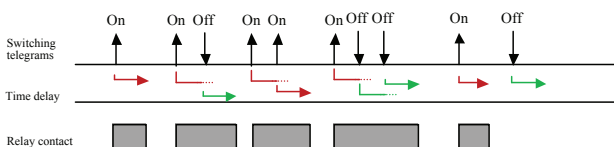

h) Delay before ON + Delay before OFF + Auto Switch OFF

