

	100 V~ - 240 V~
	50 / 60 Hz
	8 mm 2 x 2,5 mm ²
	-25°C / +45°C
	PIR
	150 lux
	15 min.
	Ø 5 m
	15 m

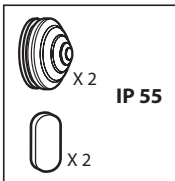

230 V~	2000 W	8,5 A	1000 VA	4,3 A	1000 VA	4,3 A	10x(2x36 W)	4,3 A
110 V~	1000 W		500 VA		500 VA		5x(2x36 W)	

230 V~	250 W	1 A	250 W	1 A	250 W	1 A	500 VA	2,1 A
110 V~	125 W		125 W		125 W		250 VA	

230 V~	500 VA	2,1 A max.	I max. ≤ 2,1 A
110 V~	250 VA		
U ≤ 30 V=	2,1 A max.		

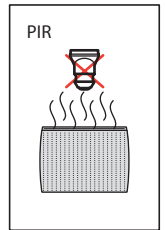
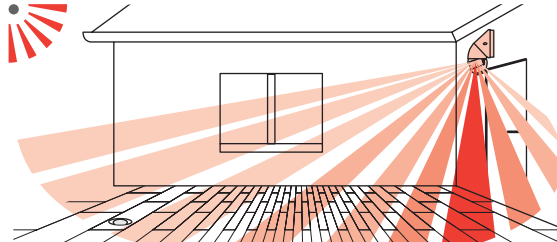
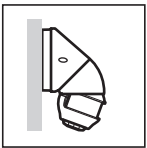
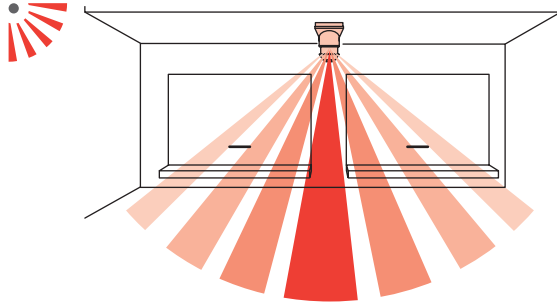
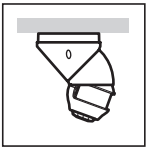
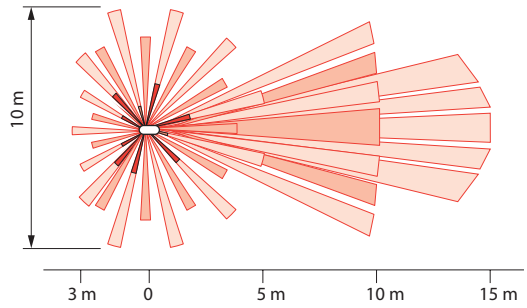
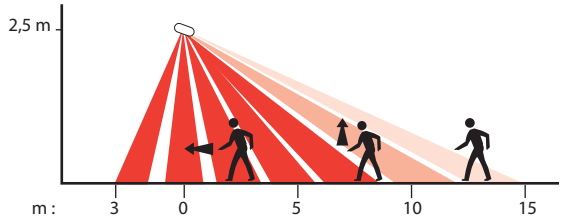
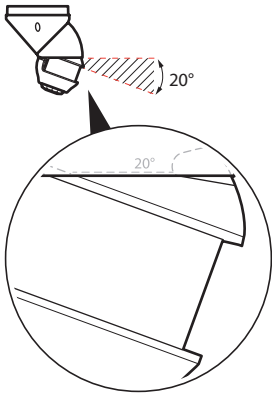

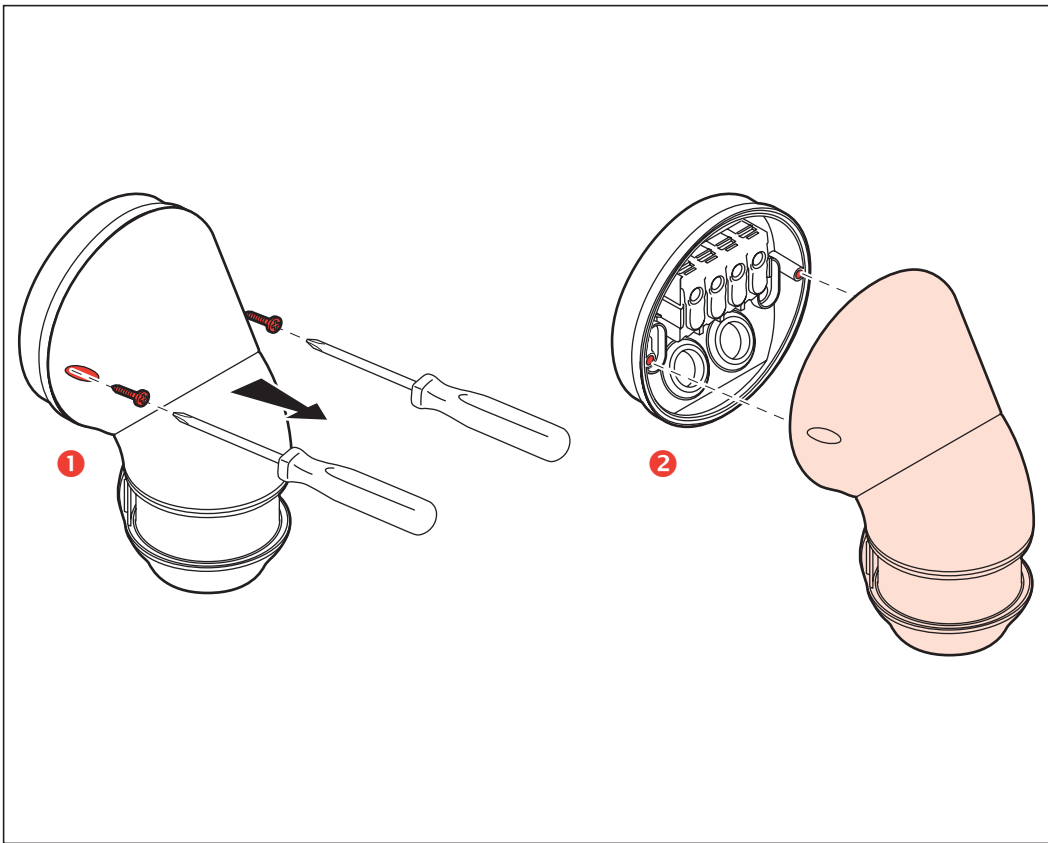
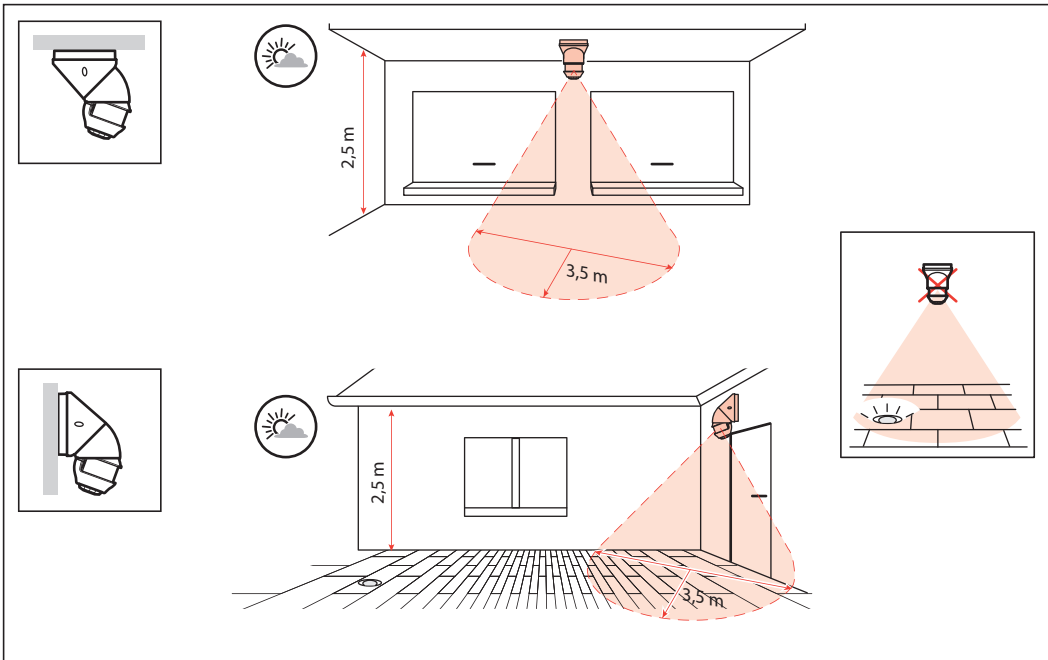

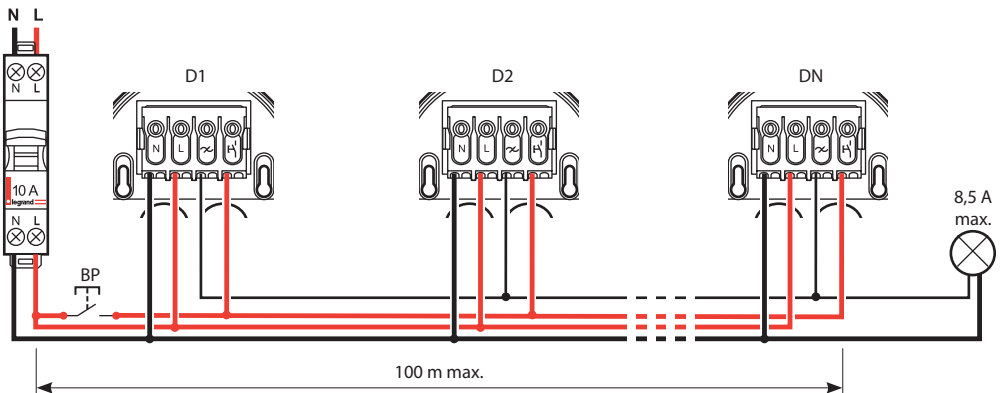
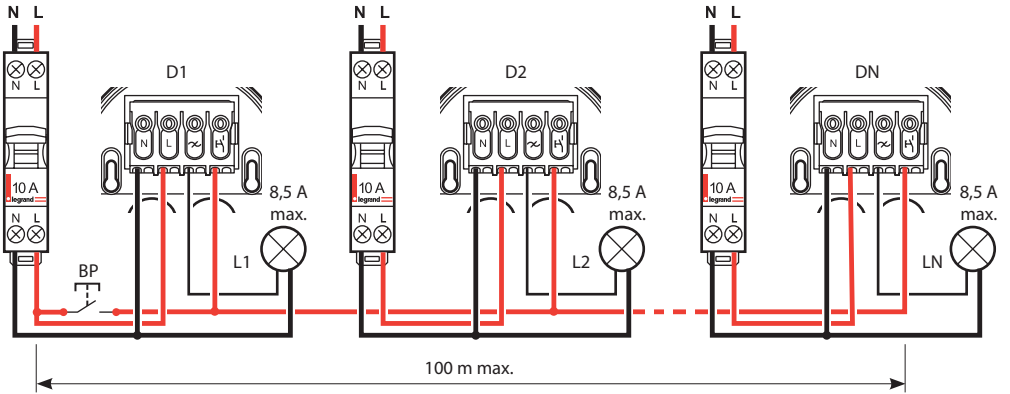
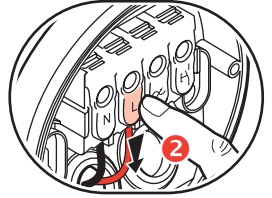
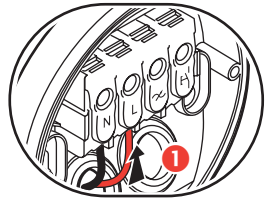
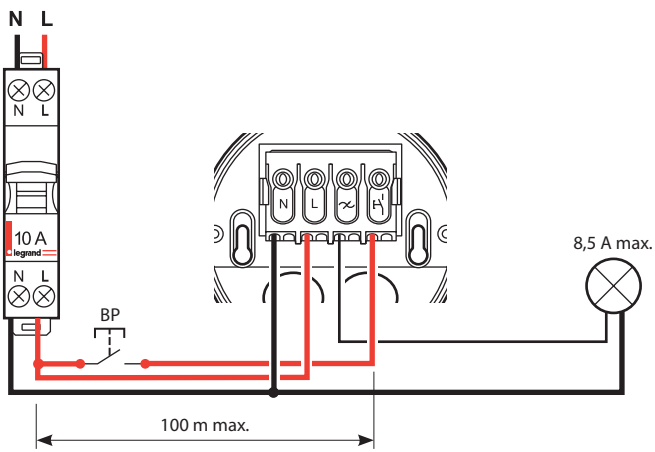

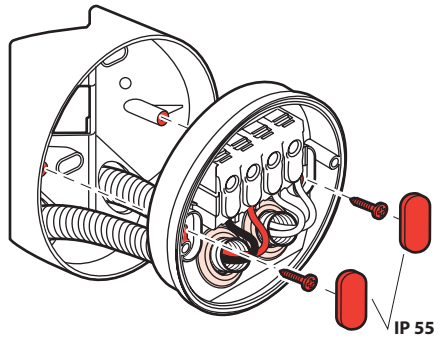
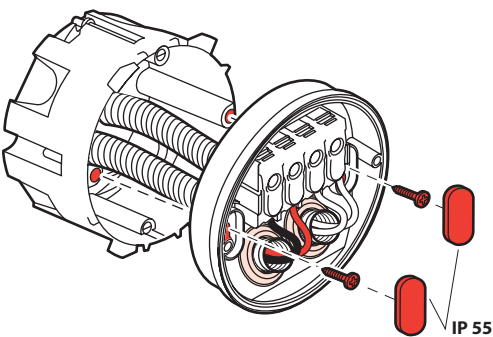
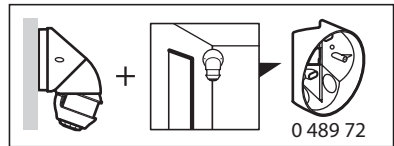
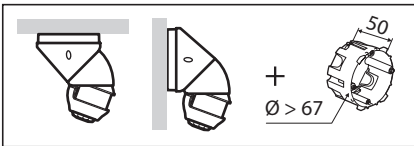
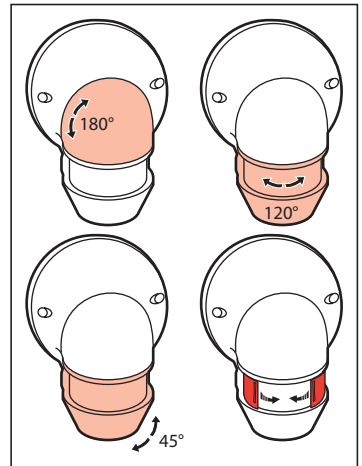
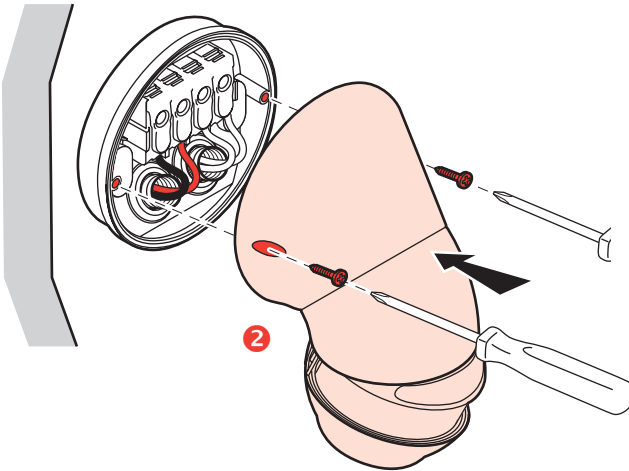
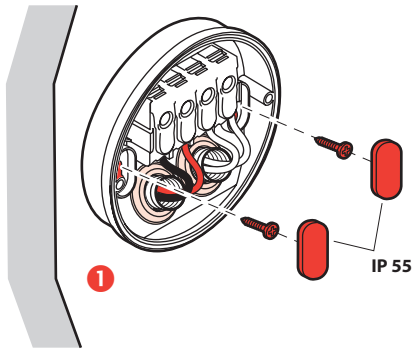
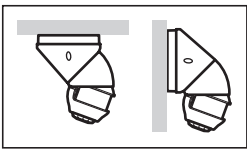



Auto ON/OFF

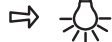
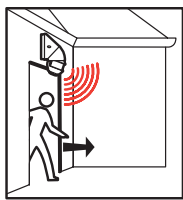

Manual ON / Auto OFF



- Réf. 0 882 40 : Passerelle de configuration
- Cat. No(s) 0 882 40 : Configuration tool



&



Application: «Legrand Close Up»

- À la première utilisation: Télécharger l'application Legrand Close Up sur l' Apple Store ou le Play Store.
- On first use: Download the Legrand Close Up app from Apple Store or Play Store



App Store



Google Play



- Pour plus de renseignements sur les paramètres, reportez vous à la fiche technique de la passerelle de configuration Réf. 0 882 40.
- For more information about setting parameters, refer to the data sheet for the configuration gateway Cat. No. 0 882 40.

	5 - 1275 lux
	5 sec - 59 min 59 sec
	25% - 50% - 75% - 100%
Mode	Auto - Manual - Walkthrough

- Détecteur/capteur PIR 180° à 270°
- PIR sensor 180° to 270°

- Détecteur/capteur PIR 360°
- PIR sensor 360°

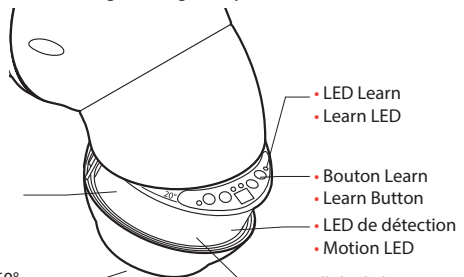

- LED Learn
- Learn LED

- Bouton Learn
- Learn Button

- LED de détection
- Motion LED

- Cellule de luminosité
- Daylight sensor