

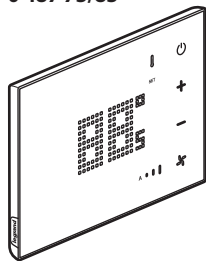







0 487 73/83

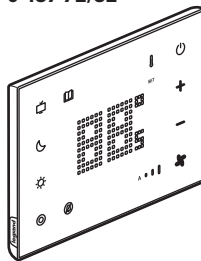

	18-27 Vdc
	25 mA
	▲ +40 °C 0 °C

0 487 72/82



	18-27 Vdc
	30 mA
	▲ +40 °C 0 °C

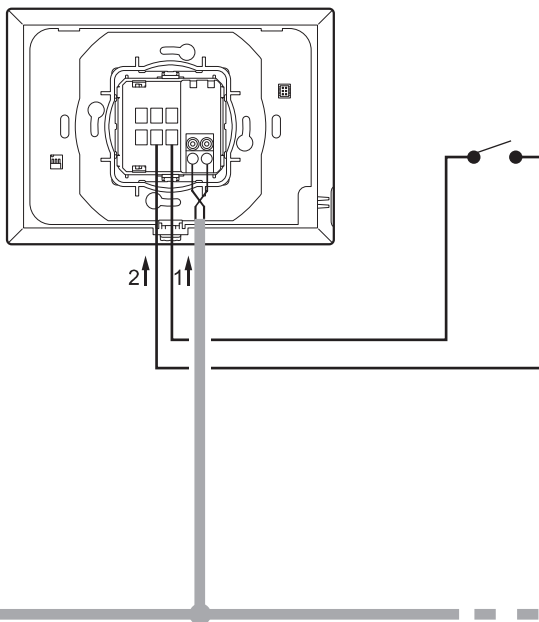

- Pour plus d'informations, se reporter aux guides techniques
- Refer to technical guides for all functions details
- Consultare la documentazione tecnica per tutti i dettagli funzionali

