

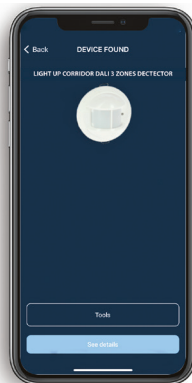

- Documentation technique disponible dans votre langue => Scanner le QR code
- Technical documentation available in your language => Scan the QR code
- Documentación técnica disponible en su idioma => Escanear el código QR
- Documentazione tecnica disponibile nella vostra lingua => Scansionare il codice QR
- Technische documentatie beschikbaar in jouw taal. => Scan de QR-code

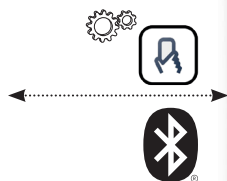

Legrand CLOSE UP

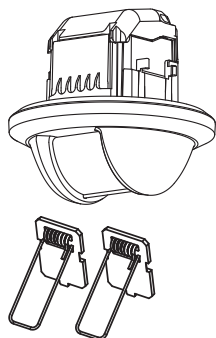

	110 - 230 V~
	50 / 60 Hz
	2 x 1.5 mm <sup>2</sup> ou/ou 1 x 2.5 mm <sup>2</sup>
	-10°C / +30°C
	PIR
	100 lux
	<ul style="list-style-type: none"> <li>• Mode Passage</li> <li>• Walkthrough mode</li> </ul>
	10 mn

Hauteur/Height 1.7 m mini	3 m x 24m (2.5 m)	
<b>Bluetooth®</b>	5.0 compatible 4.2	<ul style="list-style-type: none"> <li>• Portée : 10 m</li> <li>• Reach: 10 m</li> </ul>
Radio	2.4 - 2.483 GHz	
	<b>Garantie/ Guaranteed</b>	<b>Maximum</b>
	<ul style="list-style-type: none"> <li>-V- 16 V</li> <li>-A- 100 mA</li> </ul>	<ul style="list-style-type: none"> <li>-V- 16 V</li> <li>-A- 130 mA</li> </ul>
<ul style="list-style-type: none"> <li>• Nombre de ballast maximum</li> <li>• Maximum number of ballast units</li> </ul>	50	
<ul style="list-style-type: none"> <li>• Consommation en veille :</li> <li>• Standby consumption :</li> </ul>	Charge/Load OFF → 0,85 W	Charge/Load ON → 0,85 W

- F (Fréquence) : 2,4 à 2,483 GHz
- P (Puissance) : <100 mW
- F (Frequency) : 2.4 to 2.483 GHz
- P (Power) : <100 mW

- Le soussigné, **LEGRAND**, déclare que l'équipement radioélectrique du type réf. **0 485 56** est conforme à la directive **2014/53/UE**. Le texte complet de la déclaration UE de conformité est disponible à l'adresse suivante : [www.legrand.com/ecatalogue](http://www.legrand.com/ecatalogue)
- **LEGRAND**, declares that radio equipment of the type Cat. no. **0 485 56** complies with Directive **2014/53/EU**. The full text of the EU declaration of conformity can be found at: [www.legrand.com/ecatalogue](http://www.legrand.com/ecatalogue)

• Les détecteurs LIGHT UP DALI - 3 zones permettent la commande de 3 zones d'éclairage :

- variation côté fenêtre
- variation côté couloir
- ON/OFF côté tableau

Une commande sans fils sans pile ne commande que la sortie ON/OFF de la partie "Tableau"

Un bouton poussoir filaire commande les deux autres zones en variation.

• The LIGHT UP DALI 3-zone detectors control 3 lighting zones:

- dimming on the window side
- dimming on the corridor side
- ON/OFF on the switchboard side

A wireless battery/less control, only controls the ON/OFF output on the panel

A wired push-button controls the other two zones in dimming mode.



- Retour configuration usine
- Reset button

- Capteur infra-rouge
- PIR sensor

- LED de présence
- Presence LED

- LED Bluetooth®
- Bluetooth® LED

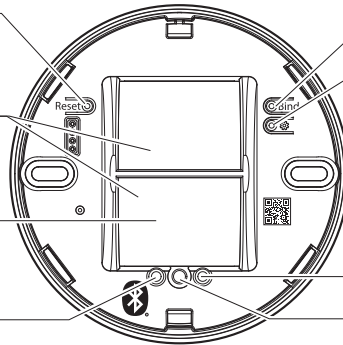

- Bouton radio bind
- Radio bind button
- Bouton radio network
- Radio network button

- LED radio
- Radio LED

- Capteur de luminosité
- Daylight sensor

<ul style="list-style-type: none"> <li>• Bouton radio network</li> <li>• Radio network button</li> </ul>	<p>&lt; 0.5s Rejoindre un réseau / Ouverture et fermeture réseau</p> <p>&gt; 5s Reset Radio</p>	<p>&lt; 0.5s Join network / Opening and closing the network</p> <p>&gt; 5 s Radio reset</p>	
<ul style="list-style-type: none"> <li>• Bouton bind</li> <li>• Radio bind button</li> </ul>	<p>&lt; 0.5s Création réseau / Initiator binding</p> <p>&gt; 5s Target Binding</p>	<p>&lt; 0.5s Network creation / Binding Initiator</p> <p>&gt; 5 s Target Binding</p>	
<ul style="list-style-type: none"> <li>• Bouton Reset</li> <li>• Reset button</li> </ul>	<p>&lt; 0.5s Redémarrage</p> <p>&gt; 5s Retour configuration Usine</p>	<p>&lt; 0.5s Reboot</p> <p>&gt; 5s Return to factory settings</p>	
<ul style="list-style-type: none"> <li>• LED radio</li> <li>• Radio LED</li> </ul>	Echec Opération radio Reset produit ( <i>rouge flash</i> )	Radio operation failed Product reset ( <i>flashing red</i> )	
	Réseau radio ouvert ( <i>magenta fixe</i> )	Open radio network ( <i>steady magenta</i> )	
	Procédure de join réseau en cours ( <i>magenta clignotant</i> )	Network join procedure in progress ( <i>blinking magenta</i> )	
	Procédure de binding en cours ( <i>bleu clignotant</i> )	Binding procedure in progress ( <i>blinking blue</i> )	
	Mise à jour ( <i>cyan clignotant</i> )	Update ( <i>blinking Cyan</i> )	
	Anomalie produit ( <i>blanc fixe</i> )	Product anomaly ( <i>steady white</i> )	
	Démarrage ( <i>jaune fixe</i> )	Start-up ( <i>steady yellow</i> )	
<ul style="list-style-type: none"> <li>• LED de présence</li> <li>• Presence LED</li> </ul>	80s au démarrage du produit 1s à chaque détection ( <i>vert fixe</i> )	80s at product start-up 1s each detection ( <i>steady green</i> )	
<ul style="list-style-type: none"> <li>• LED Bluetooth®</li> <li>• Bluetooth® LED</li> </ul>	Produit appairé avec un smartphone ( <i>bleu fixe</i> )	Product paired with a smartphone ( <i>steady blue</i> )	

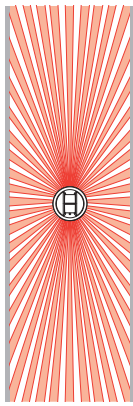

• Couloir • Corridor

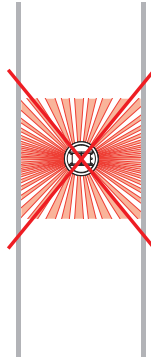

• Poteau  
• Post

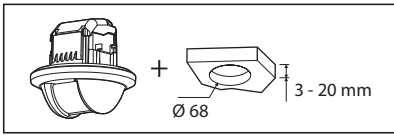

- Le montage et le câblage doivent être réalisés hors tension.
- *Merci de suivre scrupuleusement les Consignes de Sécurité.*
- Installation and wiring must be carried out with the power off.
- *Please follow the Safety Instructions carefully.*

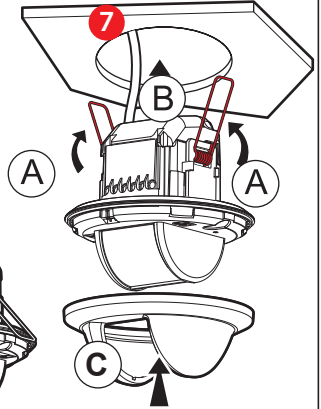
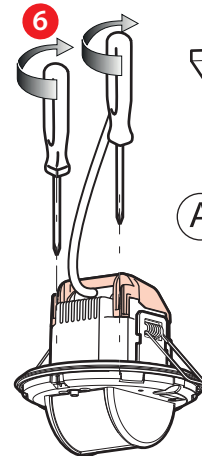
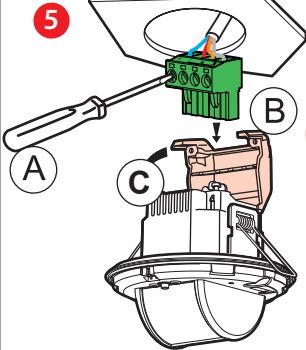
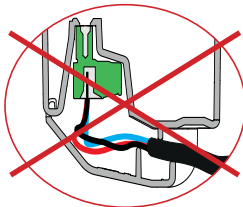
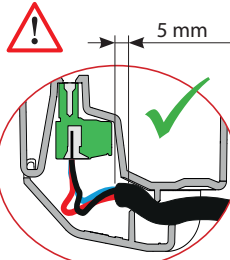
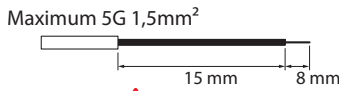
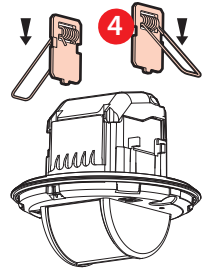
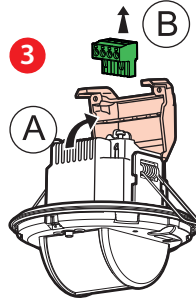
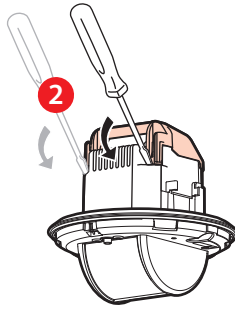
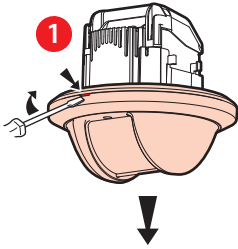

- **⚠** Le détecteur **0 485 56** est configuré pour piloter des ballasts DALI dimmables; il est possible de lui associer des actionneurs DALI (ON/OFF) pour cela il faut à partir de votre smartphone en utilisant l'application «**Legrand Close Up**» modifier le type de charge utilisée, dans ce cas «**Non Dimmable**»

- **⚠** The **0 485 56** detector is configured to control dimmable DALI ballasts; it is possible to link DALI actuators (ON/OFF) to it. To do this, use the «**Legrand Close Up**» application on your smartphone to change the type of load used, in this case «**No Dimming**».

## • Câblage

- (\*) Ce produit peut être commandé par :
  - Une commande sans fils sans pile (ON/OFF sans variation) Ou
  - Un bouton poussoir filaire (ON/OFF et variation)
 Et il peut piloter (sans fils) une prise connectée.

## • Wiring

- (\*) This product can be controlled by:
  - A wireless batteryless control (ON/OFF without dimming) Or
  - A wired push-button (ON/OFF and dimming)
 And it can control (in wireless mode) a connected outlet.

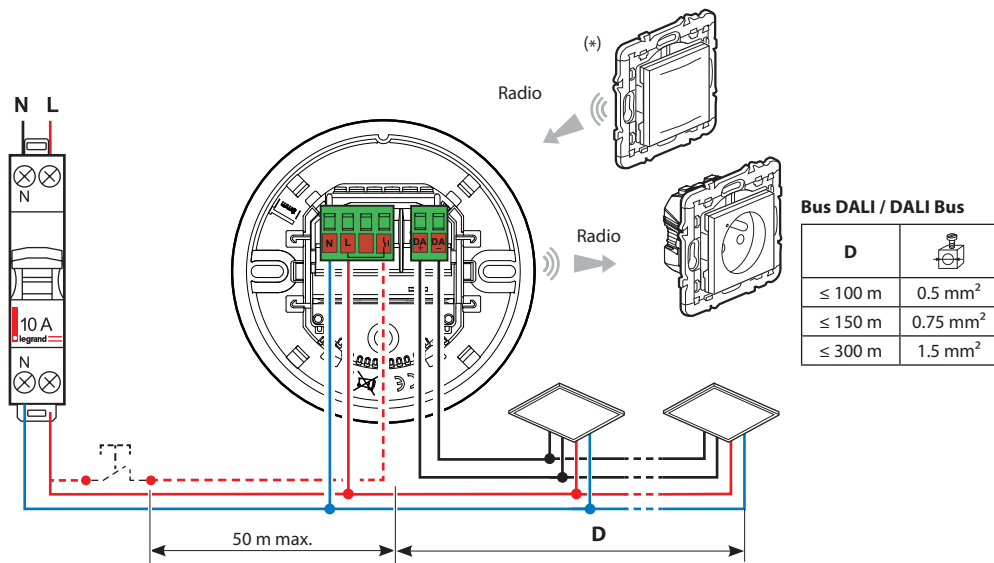

- La distance maximum du bouton poussoir filaire à l'entrée auxiliaire est de 50 m.

- The maximum distance from the wired push-button to the auxiliary input is 50 m.

### • ATTENTION :

Le détecteur fournit l'alimentation du BUS DALI.  
**Ne Pas** connecter 2 détecteurs sur le même BUS DALI.

### • CAUTION :

The sensor supplies power to the DALI BUS.  
**Do not** connect 2 sensors to the same DALI BUS.

(\*)

- Possibilité de combiner une commande d'éclairage sans fils et sans pile (maximum 2 par détecteurs)
- Possibility of combining a wireless batteryless control (maximum 2 per sensor)

Références / Cat.Nos 0 677 23L/73L/79L, 0 770 53L, 6 000 83L, 5 742 10/39/55, 5 743 24, 7 418 13L/43L/73L

- et une prise connectée (maximum 5 par détecteurs),
- and a connected outlet (maximum 5 per sensor)

Références / Cat.Nos 0 677 25A/75A, 0 648 95A, 0 777 11LA, 6 003 91A, 5 742 56/57/58/59, 7 419 11/41/71

- suivant la description des procédures du *Guide LIGHT UP*
- as described in the *LIGHT UP Guide*

• **Maitre/Esclave**

- Le produit est configuré par défaut comme **Primaire**. Pour le passer **Secondaire**, suivre la description dans le **Guide technique LIGHT UP**.
- Le produit **Maitre** ne pourra être associé qu'avec 5 détecteurs maximum configurés en esclave.

• **Master/Slave**

- The product is configured as **Master** by default. To change it to **Slave**, follow the description in the **LIGHT UP Technical Guide**.
- The **Master** product can only be associated with a maximum of 5 slave sensors.

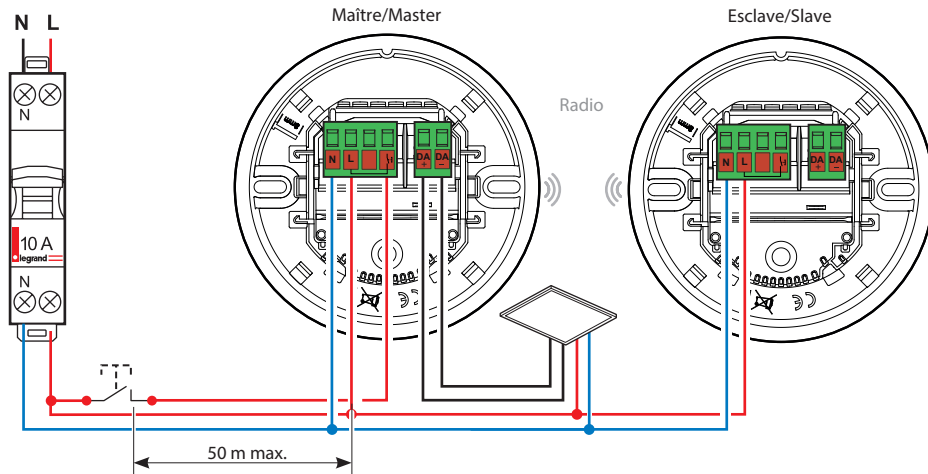

- L'esclave permet d'étendre la zone de détection. Aucune charge ne lui sera associée.
- Dans le cas d'une utilisation en «Maitre/Esclave», le bouton poussoir filaire devra être uniquement connecté au détecteur «Maitre».

- The **Slave** product extends the detection area. No load will be associated with it.
- If used in "Master/Slave" mode, the wired push-button should only be connected to the "Master" detector.

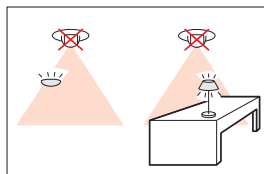
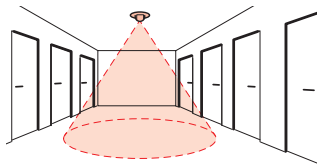
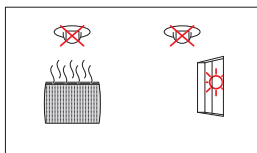
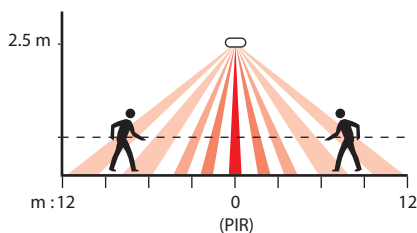



### Auto ON/OFF



### Manual ON / Auto OFF



- Approche axiale
- Walk towards

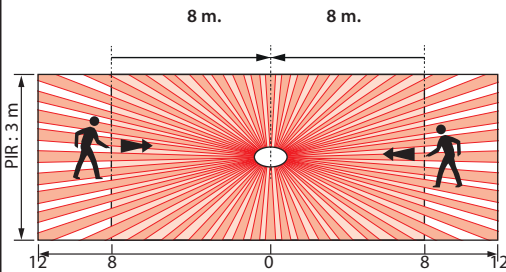

- Approche transversale
- Walk across

