

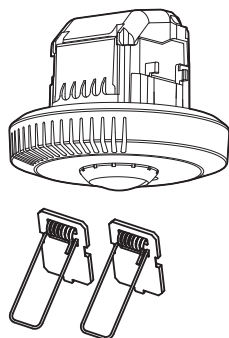

- Documentation technique disponible dans votre langue => Scanner le QR code
- Technical documentation available in your language => Scan the QR code
- Documentación técnica disponible en su idioma => Escanear el código QR
- Documentazione tecnica disponibile nella vostra lingua => Scansionare il codice QR
- Technische documentatie beschikbaar in jouw taal. => Scan de QR-code



Legrand CLOSE UP









	110 - 230 V~
	50 / 60 Hz
	2 x 1.5 mm ² ou/ or 1 x 2.5 mm ²
	+5°C / +30°C
	PIR
	300 lux
	<ul style="list-style-type: none"> • Mode Passage • Walkthrough mode
	15 mn
<ul style="list-style-type: none"> • Capteur de luminosité • Daylight sensor 	5 → 1275 lux
<ul style="list-style-type: none"> • Capteur d'humidité • Humidity sensor 	20 % → 80 %
<ul style="list-style-type: none"> • Capteur sonore • Sound sensor 	38 → 120 dB SPL

Hauteur/Height	Ø 12 m (2.5 m)	
Bluetooth®	5.0 compatible 4.2	<ul style="list-style-type: none"> • Portée : 10 m • Reach: 10 m
Radio	2.4 - 2.483 GHz	
	Garantie/ Guaranteed	Maximum
	<ul style="list-style-type: none"> –V– 16 V –A– 100 mA 	<ul style="list-style-type: none"> –V– 16 V –A– 130 mA
<ul style="list-style-type: none"> • Nombre de ballast maximum • Maximum number of ballast units 	50	
<ul style="list-style-type: none"> • Consommation en veille : • Standby consumption : 	Charge/Load OFF → 1,15 W	Charge/Load ON → 1,9 W
<ul style="list-style-type: none"> • Capteur de température • Temperature sensor 	0°C / +50°C	
<ul style="list-style-type: none"> • Capteur COVt • VOcT sensor 	0 → 10 000 ppb	
<ul style="list-style-type: none"> • Niveau Qualité de l'air • IAQ level 	1.0 → 5.0	
<ul style="list-style-type: none"> • Niveau de CO₂ estimé • Estimated CO₂ level 	400 → 5000 ppm	

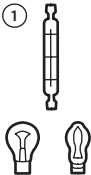
F (Fréquence) : 2,4 à 2,483 GHz
P (Puissance) : <100 mW

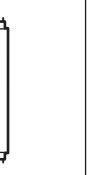
F (Frequency) : 2.4 to 2.483 GHz
P (Power) : <100 mW

• Le soussigné, **LEGRAND**, déclare que l'équipement radioélectrique du type réf. **0 485 71** est conforme à la directive **2014/53/UE**. Le texte complet de la déclaration UE de conformité est disponible à l'adresse suivante : **www.legrand.com/ecatalogue**
 • **LEGRAND** declares that radio equipment of the type Cat. no. **0 485 71** complies with Directive **2014/53/EU**. The full text of the EU declaration of conformity can be found at: **www.legrand.com/ecatalogue**

① 		② 		③ 		④ 		⑤ 		⑥ 		⑦ 		
230 V~	1500 W	6.5 A	1000 VA	4.3 A	10x(2x36 W)	5x(2x36 W)	4.3 A	500 VA	2.1 A	1000 VA	4.3 A	350 VA	2.1 A	I max. ≤ 2A
110 V~	750 W		500 VA					250 VA		500 VA		175 VA		

- ① - Lampe à incandescence et halogène
- ② - Lampe halogène à transformateur ferromagnétique ou électronique séparé
- ③ - Tube fluorescent
- ④ - Lampe fluocompacte à ballast intégré
- ⑤ - Lampe fluocompacte à transformateur ferromagnétique ou électronique séparé
- ⑥ - Lampe à LEDs
- ⑦ - Contacteur

- ① - Incandescent and halogen lamps
- ② - Halogen lamp with separate ferromagnetic or electronic transformer
- ③ - Fluorescent tubes
- ④ - Compact fluorescent lamp with integrated ballast
- ⑤ - Compact fluorescent lamps with transformer ferromagnetic or separate electronic
- ⑥ - LED lamp
- ⑦ - Contactor

• **Accessoire pour limiter la zone de détection**

• **Accessory for limiting the detection zone**

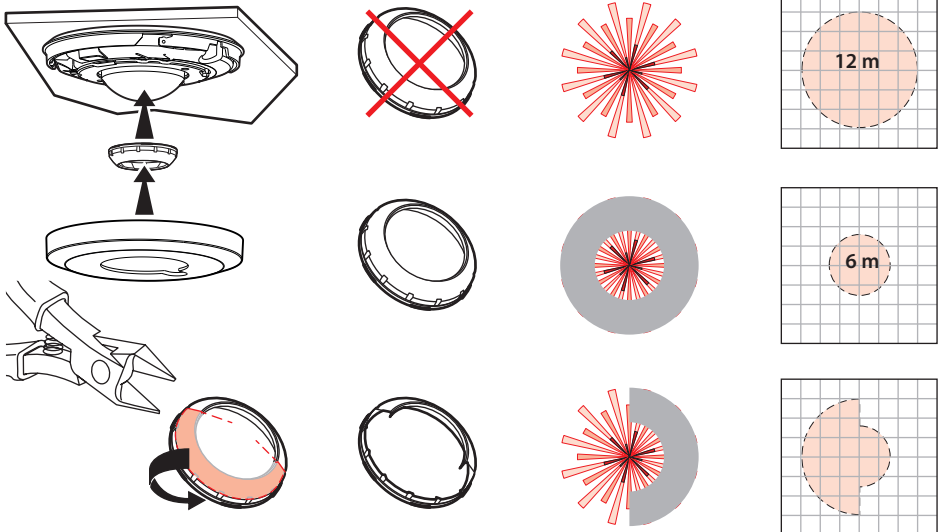

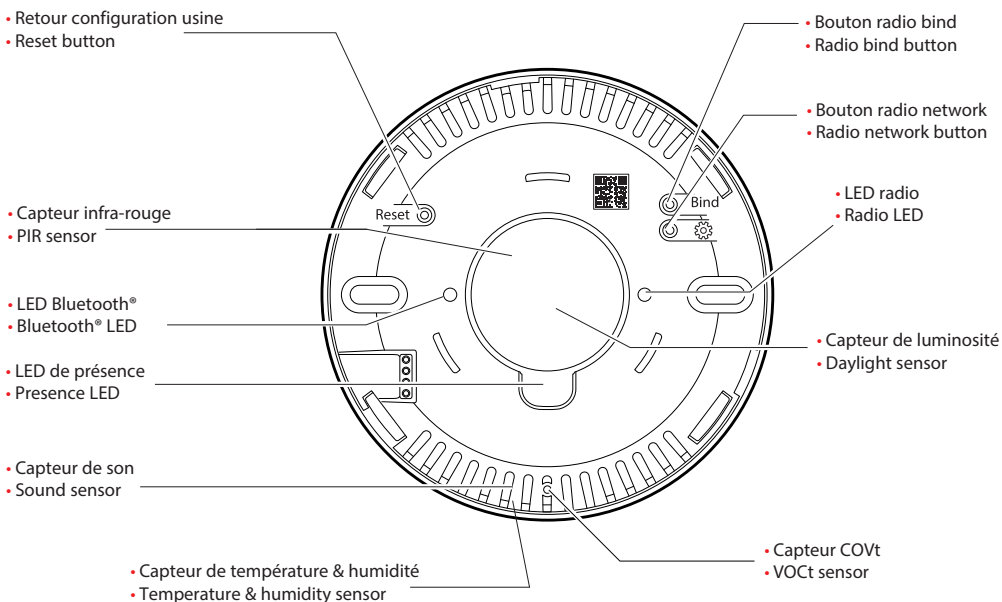

<ul style="list-style-type: none"> • Bouton radio network • Radio network button 	<ul style="list-style-type: none"> < 0.5s Rejoindre un réseau / Ouverture et fermeture réseau > 5s Reset Radio 	<ul style="list-style-type: none"> < 0.5s Join network / Opening and closing the network > 5s Radio reset 	
<ul style="list-style-type: none"> • Bouton bind • Radio bind button 	<ul style="list-style-type: none"> < 0.5s Création réseau / Initiator binding > 5s Target Binding 	<ul style="list-style-type: none"> < 0.5s Network creation / Binding Initiator > 5s Target Binding 	
<ul style="list-style-type: none"> • Bouton Reset • Reset button 	<ul style="list-style-type: none"> < 0.5s Redémarrage > 5s Retour configuration Usine 	<ul style="list-style-type: none"> < 0.5s Reboot > 5s Return to factory settings 	
<ul style="list-style-type: none"> • LED radio • Radio LED 	<ul style="list-style-type: none"> Echec Opération radio Reset produit (<i>rouge flash</i>) 	<ul style="list-style-type: none"> Radio operation failed Product reset (<i>flashing red</i>) 	
	Réseau radio ouvert (<i>magenta fixe</i>)	Open radio network (<i>steady magenta</i>)	
	Procédure de join réseau en cours (<i>magenta clignotant</i>)	Network join procedure in progress (<i>blinking magenta</i>)	
	Procédure de binding en cours (<i>bleu clignotant</i>)	Binding procedure in progress (<i>blinking blue</i>)	
	Mise à jour (<i>cyan clignotant</i>)	Update (<i>blinking Cyan</i>)	
	Anomalie produit (<i>blanc fixe</i>)	Product anomaly (<i>steady white</i>)	
	Démarrage (<i>jaune fixe</i>)	Start-up (<i>steady yellow</i>)	
<ul style="list-style-type: none"> • LED de présence • Presence LED 	<ul style="list-style-type: none"> 80s au démarrage du produit 1s à chaque détection (<i>vert fixe</i>) 	<ul style="list-style-type: none"> 80s at product start-up 1s each detection (<i>steady green</i>) 	
<ul style="list-style-type: none"> • LED Bluetooth® • Bluetooth® LED 	Produit appairé avec un smartphone (<i>bleu fixe</i>)	Product paired with a smartphone (<i>steady blue</i>)	

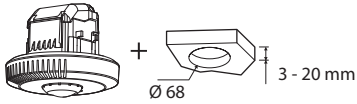

- Le montage et le câblage doivent être réalisés hors tension. **Merci de suivre scrupuleusement les Consignes de Sécurité.**
- Installation and wiring must be carried out with the power off. **Please follow the Safety Instructions carefully.**

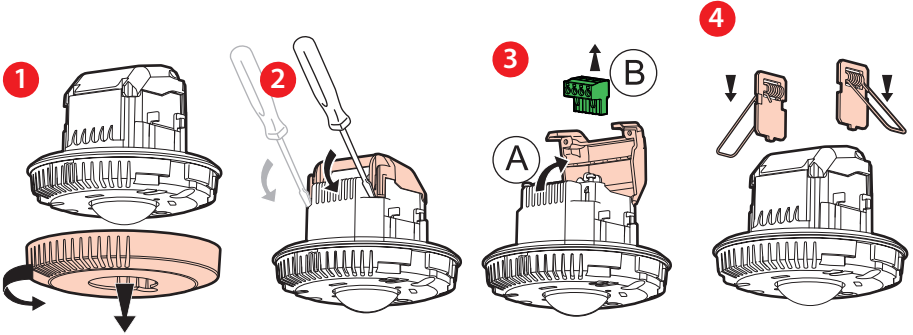

Maximum 5G 1,5mm²

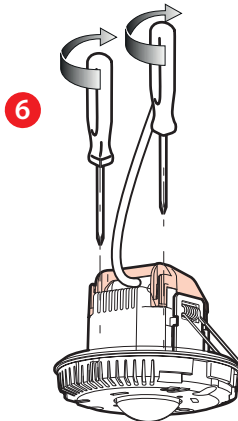
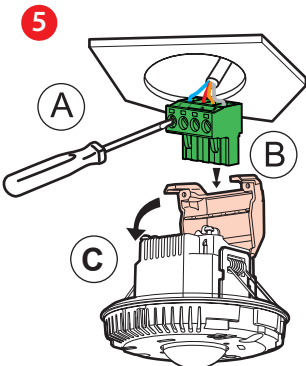
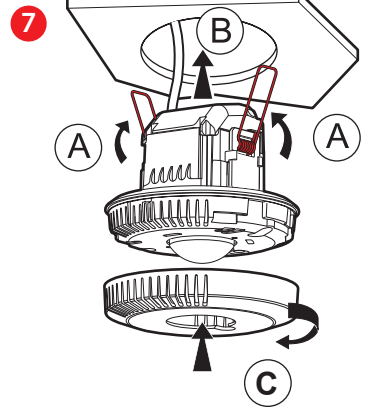
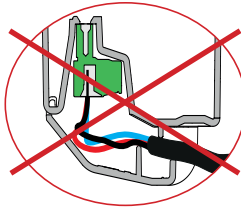
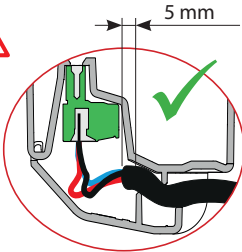
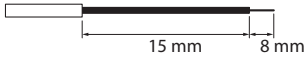

• Câblage

- (*) Ce produit peut être commandé par :
 - Une commande sans fils sans pile (ON/OFF sans variation) Ou
 - Un bouton poussoir filaire (ON/OFF et variation)
 Et il peut piloter (sans fils) une prise connectée.

• Wiring

- (*) This product can be controlled by:
 - A wireless batteryless control (ON/OFF without dimming) Or
 - A wired push-button (ON/OFF and dimming)
 And it can control (in wireless mode) a connected outlet.

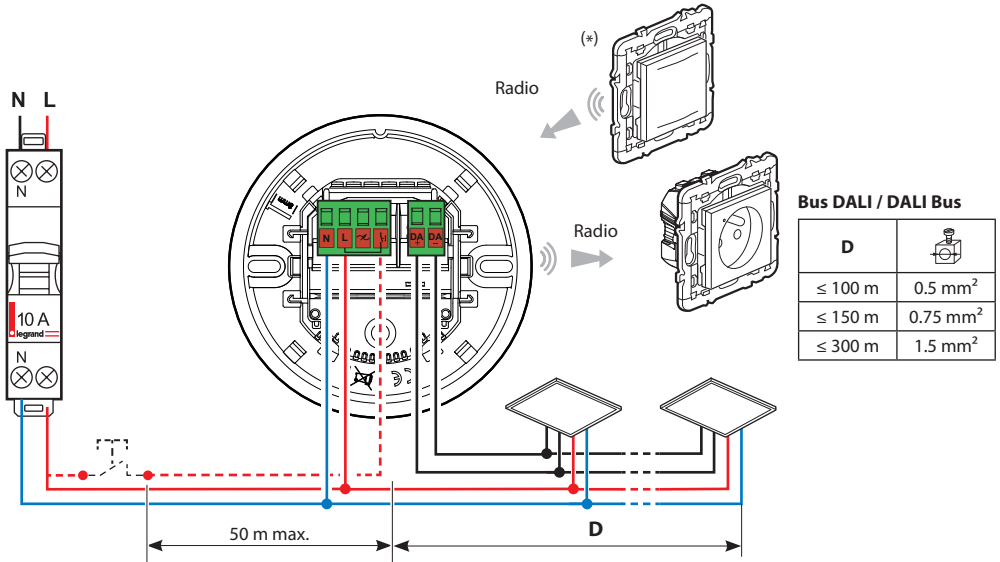

- La distance maximum du bouton poussoir filaire à l'entrée auxiliaire est de 50 m.

- The maximum distance from the wired push-button to the auxiliary input is 50 m.

• ATTENTION :

Le détecteur fournit l'alimentation du BUS DALI.
Ne Pas connecter 2 détecteurs sur le même BUS DALI.

• CAUTION :

The sensor supplies power to the DALI BUS.
Do not connect 2 sensors to the same DALI BUS.

(*)

- Possibilité de combiner une commande d'éclairage sans fils et sans pile (maximum 2 par détecteurs)
- Possibility of combining a wireless batteryless control (maximum 2 per sensor)

Références / Cat.Nos 0 677 23L/73L/79L, 0 770 53L, 6 000 83L, 5 742 10/39/55, 5 743 24, 7 418 13L/43L/73L

- et une prise connectée (maximum 5 par détecteurs),
- and a connected outlet (maximum 5 per sensor)

Références / Cat.Nos 0 677 25A/75A, 0 648 95A, 0 777 11LA, 6 003 91A, 5 742 56/57/58/59, 7 419 11/41/71

- suivant la description des procédures du **Guide LIGHT UP**
- as described in the **LIGHT UP Guide**

• Câblage

• Type de charge "VARIATION"

• Wiring

• Type of load "DIMMING"



Le relais est dédié à l'alimentation du ballast pour réduire la consommation d'énergie, la mise hors tension des ballasts est retardée de 5 minutes.

The relay is dedicated to powering the ballast to reduce energy consumption, and there is a 5 minute delay before the ballasts switch off.

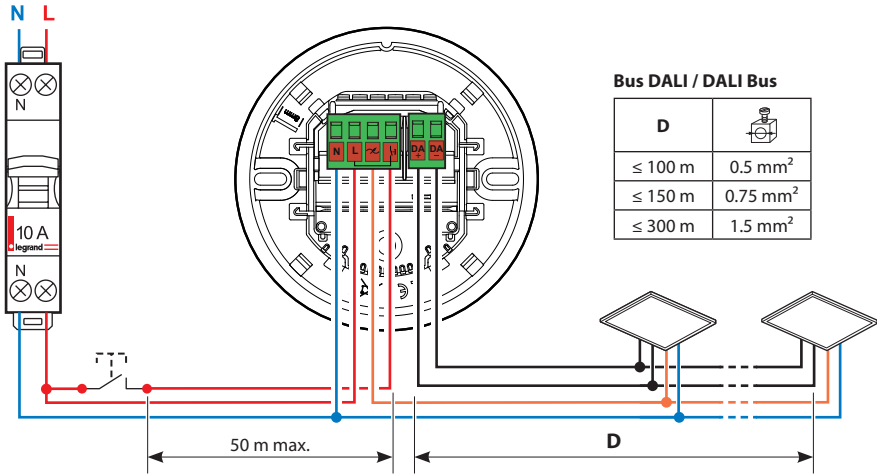

La distance maximum du bouton poussoir filaire avec l'entrée auxiliaire est de 50 m

The maximum distance from the wired push-button to the auxiliary input is 50 m

• Type de charge "NON DIMMING"

• Type of load "NO DIMMING"

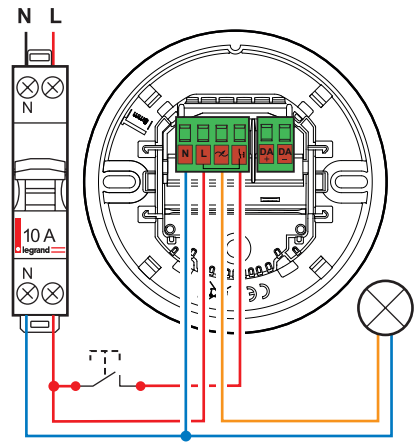
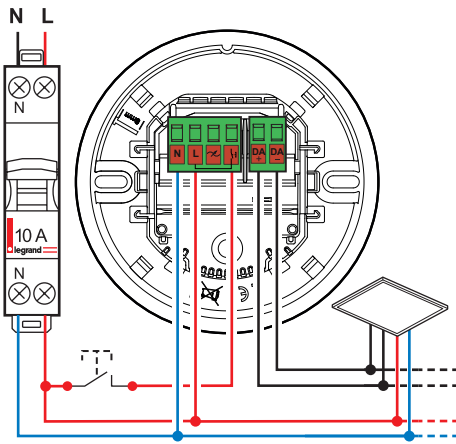

Le détecteur 0 485 71 est configuré pour piloter des ballasts DALI dimmables; il est possible de lui associer des actionneurs DALI (ON/OFF) pour cela il faut à partir de votre smartphone en utilisant l'application «Legrand Close Up» modifier le type de charge utilisée, dans ce cas «Non Dimmable»



The 0 485 71 detector is configured to control dimmable DALI ballasts; it is possible to link DALI actuators (ON/OFF) to it. To do this, use the «Legrand Close Up» application on your smartphone to change the type of load used, in this case «No Dimming».

• **Maitre/Esclave**

- Le produit est configuré par défaut en **Maitre**.
Pour le passer en **Esclave**, suivre la description dans le **Guide technique LIGHT UP**.
- Le Maitre ne pourra être associé qu'avec 5 détecteurs maximum configurés en esclave.

• **Master/Slave**

- The product is configured as **Master** by default.
To change it to **Slave**, follow the description in the **LIGHT UP Technical Guide**.
- The Master can only be associated with a maximum of 5 slave sensors.

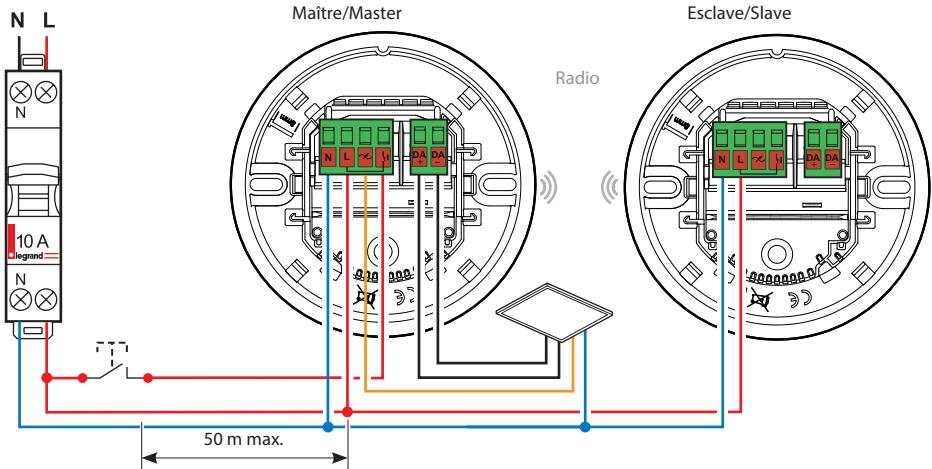

- L'esclave permet d'étendre la zone de détection. Aucune charge ne lui sera associée.
- Dans le cas d'une utilisation en «**Maitre/Esclave**», le push-over devra être uniquement connecté au détecteur «**Maitre**».

- The slave extends the detection area. No load will be associated with it.
- If used in "**Master/Slave**" mode, the push-button should only be connected to the "**Master**" detector.

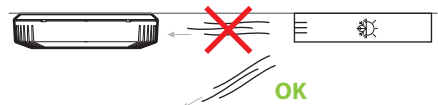
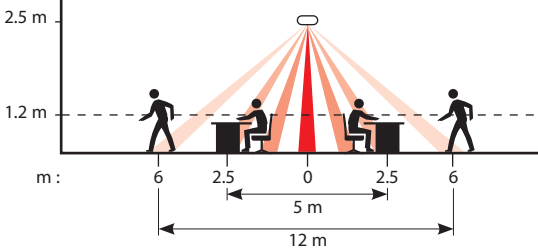

- Éviter les flux d'air direct sur les aérations des produits. Placer le détecteur à une distance supérieure à 1,5m d'une paroi vitrée afin d'éviter la réflexion de l'infrarouge.
- Avoid direct airflow over product vents. Place the detector at a distance of over 1.5m from a glass surface to avoid infra-red reflection.

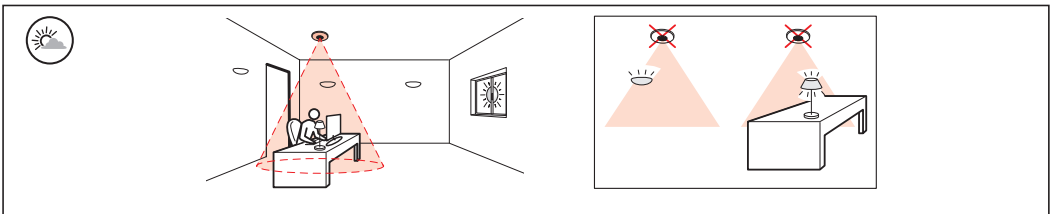
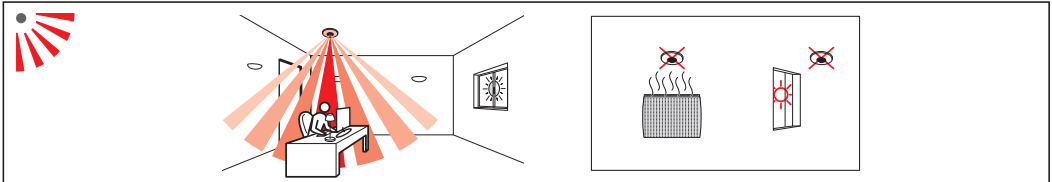



Auto ON/OFF



Manual ON / Auto OFF

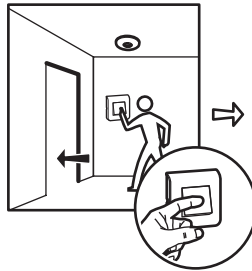
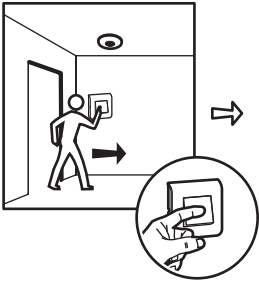

- Approche axiale
- Walk towards

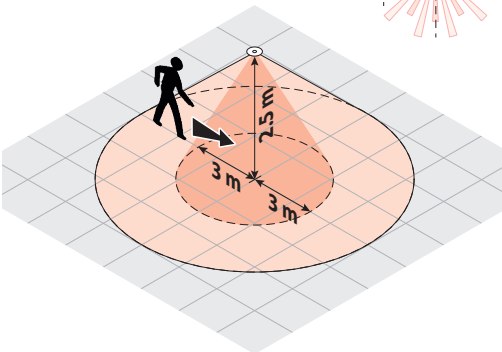
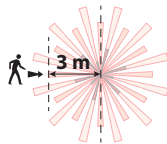

- Approche transversale
- Walk across

