

CONTENTS PAGE

1. Use 1
 2. Technical characteristics 1
 3. Dimensions 2
 4. Connection 2
 5. Operation 2
 6. Care 9
 7. Standards 9
 8. Troubleshooting 10
 9. Appendix 12

1. USE

The multifunction remote control dimmer is used to customise the device manually

5 functions which can be configured manually

- Dimmer
- Step relay
- Dimmer with status memory
- Timer
- Bi-level 1-way switch

8 functions which can be configured with the Legrand Close Up or Close Up for 002671 app via NFC

- Dimmer
- Step relay
- Dimmer with status memory
- Timer
- Bi-level 1-way switch
- 1-way switch with preset levels
- Dimmer for child's room
- Timer with switch-off warning

Compatible with dimmable energy-saving lamps (LEDs and CFLs)

Max. standby consumption: 0.2 W

Mounted on a 1-module DIN rail

Has space for inserting a supply busbar

Can be installed instead of a remote control dimmer controlled via a push-button

2. TECHNICAL CHARACTERISTICS

Voltage: 240 V~

Frequency: 50/60 Hz

Terminal type: screw

Terminal capacity: 1 x 2.5 mm² or 2 x 1.5 mm²

Weight: 60 g

Impact resistance: IK04

Penetration of solid bodies and liquid: IP20 (installation in an enclosure)

Number of modules: 1

Usage temperature: -5°C to +45°C

2. TECHNICAL CHARACTERISTICS (continued)

| | R (trailing or leading mode) | L (leading mode) | | | | |
|--------|---------------------------------|---------------------|--------------|--------|--------|------------|
| | ① | ② + | ③ | ④ | ⑤ | |
| | | | | | | |
| 240 V~ | Max. 300 W | 200 VA or 30 | 200 VA or 15 | 300 VA | 300 VA | 100 W or 8 |
| | Min. 1 W | 1 VA | 1 VA | 1 VA | 1 VA | 1 W |

| | C (trailing mode) | L (leading mode) |
|--------|----------------------|---------------------|
| | ⑥ + | ⑦ |
| | | |
| 240 V~ | Max. 200 VA or 30 | 200 VA or 10 |
| | Min. 1 VA | 1 VA |

- 1 - Halogen lamp
- 2 - ELV halogen lamp and LED lamp with separate ferromagnetic ballast
- 3 - Fan motor
- 4 - Fluorescent tubes with dimmable electronic ballast
- 5 - Compact fluorescent bulbs with dimmable built-in electronic ballast
- 6 - ELV halogen lamp and LED lamp with dimmable separate electronic ballast
- 7 - LED bulb with built-in electronic ballast

(*) Only use transformers designed to work with electronic switches.

(**) Single-phase asynchronous ceiling fan motor not combined with a luminaire (leading forced mode).

(***) Only use dimmable LEDs with this logo on the packaging.

3. DIMENSIONS

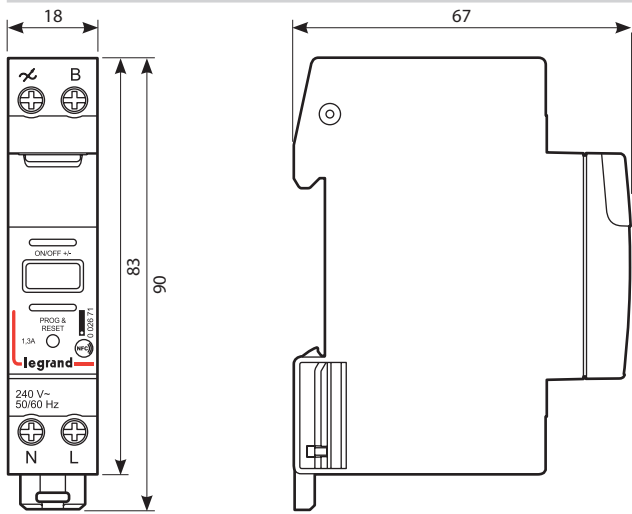

4. CONNECTION

4.1 Wiring for a single device and a single load:

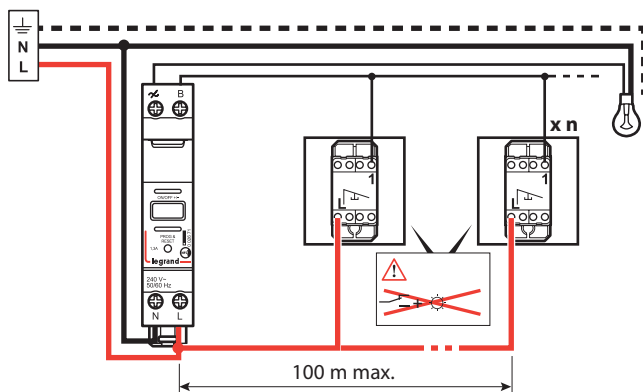

4.2 Wiring for several devices and several loads + push-buttons

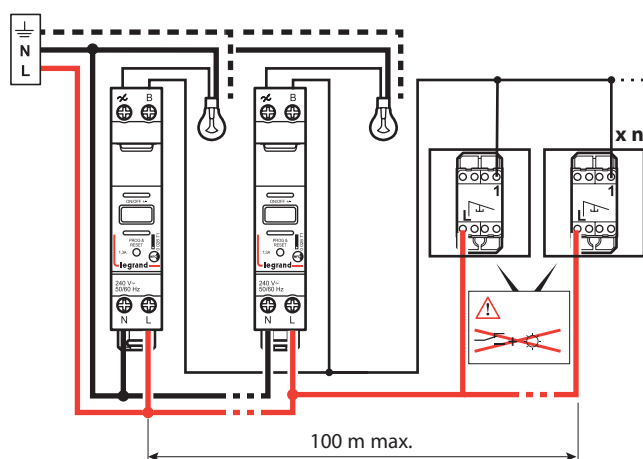

4.3 Installation advice

Leave one empty module on each side of the dimmer switch.

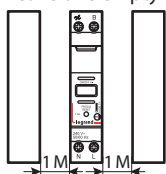

5. OPERATION

5.1 Description

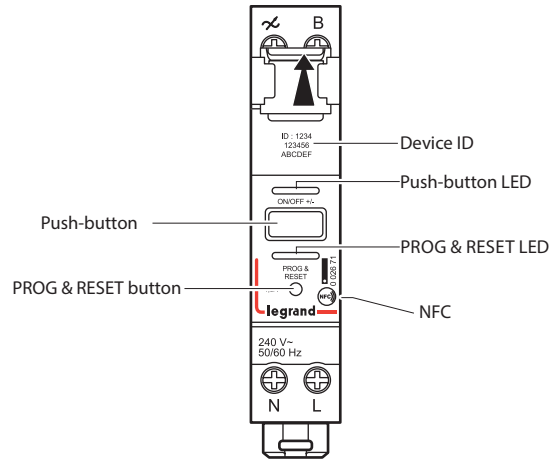

5.2 Teaching the load on 1st power-up

At the first switch-on, the load teach phase is launched. During this phase, the load will switch on, switch off, dim and sometimes flash. The push-button and PROG & RESET LEDs flash alternately in magenta during the teach phase. The teach phase lasts approximately 30 seconds. It is complete when the push-button LED lights up.

Caution:

Following a power failure and after pressing the push-button (if automatic mode has been selected), the teach phase will be launched.

5.3 Description of functions

During operation, the remote control dimmer push-button (ON/OFF) has the same function as the control button.

| | Control unit | Remote control dimmer |
|------------------|--------------|-----------------------|
| Push-button time | | |
| Short press | < 0.4 s | < 2 s |
| Long press | > 0.4 s | > 2 s |

5.3.1 Remote control dimmer without dimming level memory

Following an OFF, a **short press** on the control unit ON/OFF button will switch on the load at 100%.
 Following an ON, a **short press** on the control unit ON/OFF button will switch off the load at 100%.
 After +/- dimming the load will increase or decrease to the maximum or minimum.
 Following an OFF, a **long press** on the control unit ON/OFF button will switch on the load at 100% and then dims as far as it will go or until the button is released.
 Following an ON, a **long press** on the control unit ON/OFF button will decrease the load as far as it will go or until the button is released.

5. OPERATION (continued)**■ 5.3 Description of functions (continued)****5.3.2 Step relay**

Following an OFF, a **short press** on the control unit ON/OFF button will switch on the load at 100%.

Following an ON, a **short press** on the control unit ON/OFF button will switch off the load.

Following an OFF, a **long press** on the control unit ON/OFF button will switch on the load at 100%.

Following an ON, a **long press** on the control unit ON/OFF button will switch off the load.

5.3.3 Remote control dimmer with dimming level memory

Following an OFF, a **short press** on the control unit ON/OFF button will switch on the load at the dimming level memory (last switch-off level).

Following an ON, a **short press** on the control unit ON/OFF button will decrease the load until it switches off.

After +/- dimming the load will increase or decrease to the maximum or minimum.

Following an OFF, a **long press** on the control unit ON/OFF button will increase the load as far as it will go or until the button is released.

Following an ON, a **long press** on the control unit ON/OFF button will decrease the load as far as it will go or until the button is released.

5.3.4 Timer

The timer time is only accessible via NFC (10 minutes by default).

Following an OFF, a **short press** on the control unit ON/OFF button will switch on the load at 100% and it stays on for the predefined timer time.

Following an ON, a **short press** on the control unit ON/OFF button will restart the timer time delay.

Following an OFF, a **long press** on the control unit ON/OFF button will switch on the load at 100% and it stays on for the predefined timer time.

Following an ON, a **long press** on the control unit ON/OFF button will switch off the load.

5.3.5 Bi-level

Following an OFF, a **short press** on the control unit ON/OFF button will switch on the load at maximum level (adjustable).

Following an ON, a **short press** on the control unit ON/OFF button will decrease the load until it switches off.

Following an OFF, a **long press** on the control unit ON/OFF button will increase the load as far as preset level 1.

Following an ON, a **long press** on the control unit ON/OFF button will decrease the load as far as preset level 1, set with the change of level ramp.

5.3.6 Preset level, 4 possible preset levels (function and setting accessible via NFC)

Following an OFF, a **short press** on the control unit ON/OFF button will switch on the load at maximum level.

Other **short presses** on the control unit ON/OFF button will switch on the load at the preset levels. These levels (and the number of levels) can be modified via the "Close Up" app.

Following an OFF, a **long press** on the control unit ON/OFF button will switch on the load at maximum level.

Following an ON, a **long press** on the control unit ON/OFF button will switch off the load.

5. OPERATION (continued)**■ 5.3 Description of functions (continued)****5.3.7 Child's room (function and setting accessible via NFC only)****Caution:**

The push-button time must be longer than the switch-on time.

Following an OFF, a **short press** on the control unit ON/OFF button will switch on the load at maximum level.

Following an ON, a **short press** on the control unit ON/OFF button will switch off the load.

A **long press** on the control unit ON/OFF button will switch on the load at the preset level, then the load will decrease until it switches off in accordance with the time set.

5.3.8 Timer with switch-off warning (function and setting accessible via NFC)

Following an OFF, a **short press** on the control unit ON/OFF button will switch on the load at 100% and it stays on for the timer time, then gradually dims at an adjustable rate.

Following an ON, a **short press** on the control unit ON/OFF button will restart the timer time delay.

Following an OFF, a **long press** on the control unit ON/OFF button will switch on the load at 100% and it stays on for the predefined timer time.

Following an ON, a **long press** on the control unit ON/OFF button will switch off the load.

With switch-off, a warning is given by a decrease ramp and a standby level.

■ 5.4 Parameter setting

During parameter setting the user can select the function, the load, the mode he wishes to assign to the device.

There are two possible methods: manually or via NFC after downloading the Close Up app.

5.4.1 Manual settings

To go back to parameter-setting mode, press and hold down (> 2 s) the PROG & RESET button. The PROG & RESET LED lights up, coloured white.

The first parameter to be set is selecting the function from the device push-button.

A short press (<2 s) on the PROG & RESET button is used to scroll through the menus to select the load teach phase, force switching to leading mode or trailing mode, set the dimming minimum level and return to selecting the function.

If you make a mistake, or wish to exit parameter-setting mode, press and hold down the PROG & RESET button.

5. OPERATION (continued)

5.4 Parameter setting (continued)

5.4.1 Manual settings (continued)

5.4.1.1 Function settings (selecting the function)

1 - Pressing and holding down the PROG & RESET button enters parameter-setting mode. Following this press the PROG & RESET LED lights up, coloured white, and the push-button LED lights up in the function colour.



2 - The function is selected by a short press on the push-button. The push-button LED colour determines the chosen function.

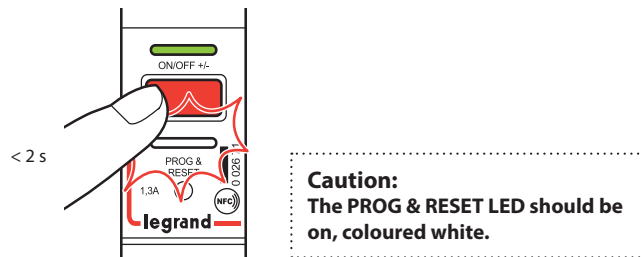

3 - The chosen function is enabled by pressing and holding down the push-button, the push-button LED starts to flash in the colour of the chosen function. This step is completed by pressing and holding down the PROG & RESET button, both LEDs go out.

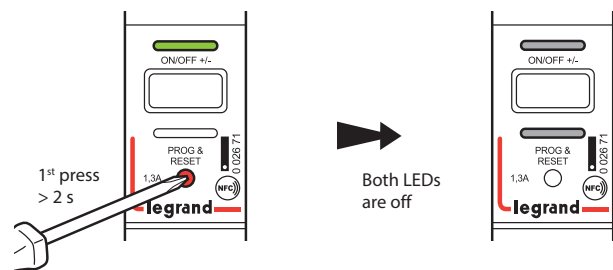
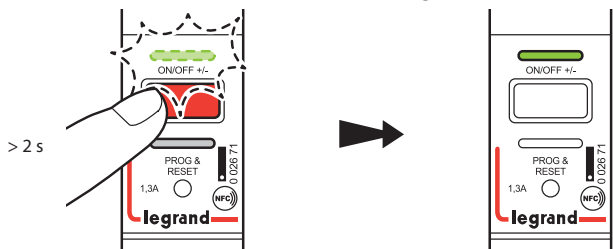

4 - To exit parameter-setting mode:

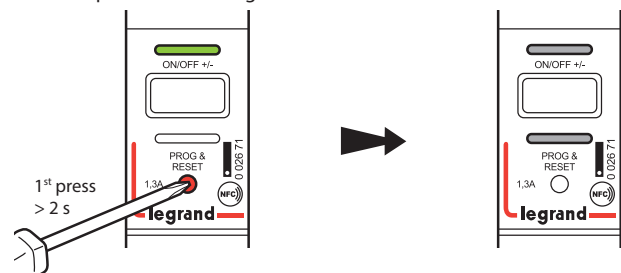

5. OPERATION (continued)

5.4 Parameter setting (continued)

5.4.1 Manual settings (continued)

5.4.1.2 Load settings (selecting the mode)

A long press followed by a short press on the PROG & RESET button accesses the different modes.

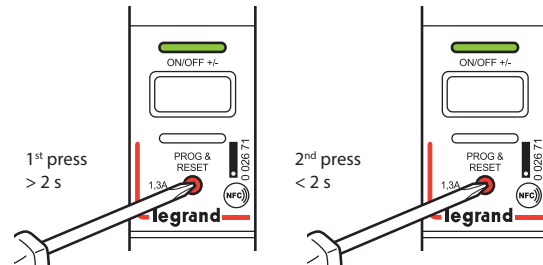

A short press on the push-button scrolls through the different modes.

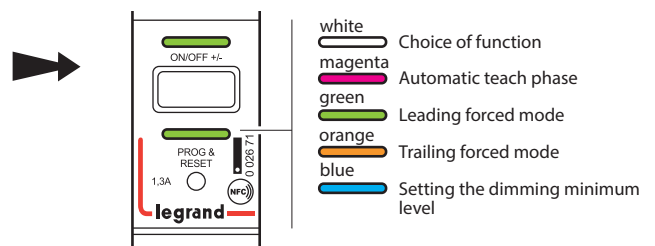

Confirm by pressing and holding down the PROG & RESET button.

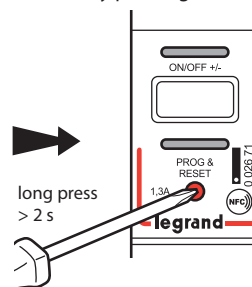

• Automatic teach phase

The PROG & RESET LED is magenta, indicating the load is in teach phase. Pressing and holding down the remote control dimmer push-button (ON/OFF) launches the teach phase; during this phase, the load will switch on, switch off, dim and sometimes flash.

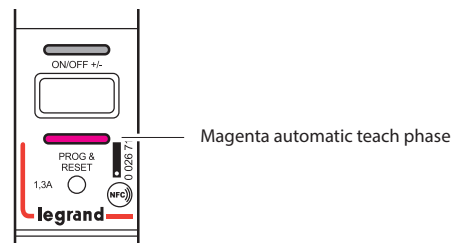

5. OPERATION (continued)

■ **5.4 Parameter setting (continued)**

5.4.1 Manual settings (continued)

5.4.1.2 Load settings (selecting the mode) (continued)

• **Automatic teach phase (continued)**

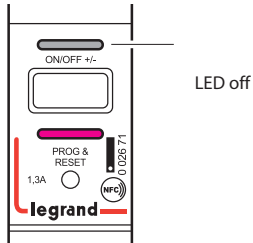

The push-button and PROG & RESET LEDs flash alternately during the teach phase.

This mode is used to determine automatically which load type is connected to the remote control dimmer.

The teach phase lasts between 15 and 40 seconds.

Following this automatic teach phase step, if dimming is not correct, refer to the **lamp test table (see Appendix)** and force the recommended mode or consult the troubleshooting section (8).

• **Leading mode**

After selecting this mode, you can then select the load to be controlled after a short press on the push-button (ON/OFF). The PROG & RESET LED is green, indicating the load has been forced to leading mode.

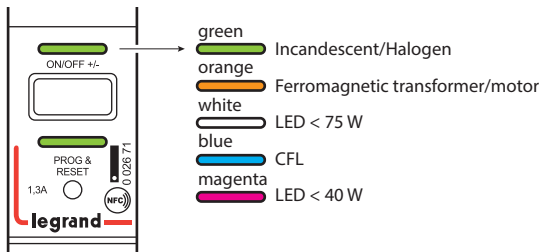

The chosen load is enabled by pressing and holding down the push-button, the push-button LED starts to flash in the colour of the chosen load. This step should be completed with a long press on the PROG & RESET button, both LEDs go out.

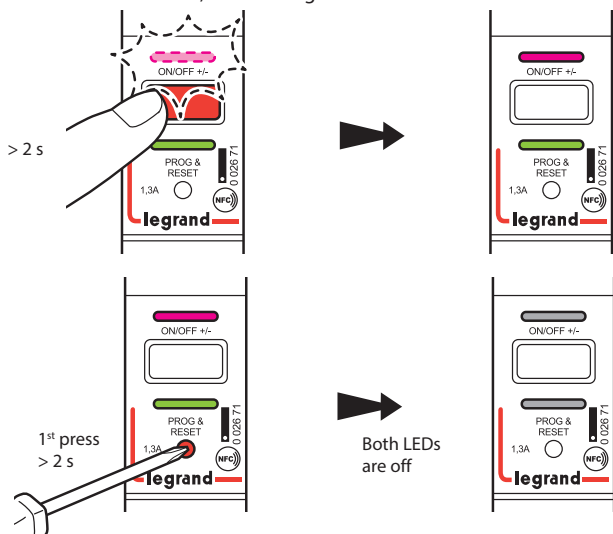

Caution:

If the load is changed, repeat the automatic teach phase or force the correct mode.

5. OPERATION (continued)

■ **5.4 Parameter setting (continued)**

5.4.1 Manual settings (continued)

5.4.1.2 Load settings (selecting the mode) (continued)

• **Trailing mode**

After selecting this mode, you can then select the load to be controlled after a short press on the push-button (ON/OFF). The PROG & RESET LED is orange, indicating the load has been forced to trailing mode.

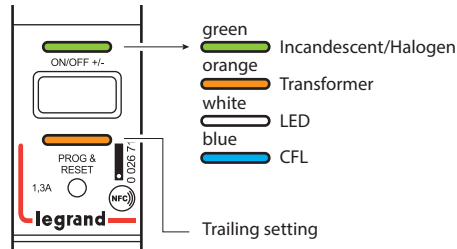

The chosen load is enabled by pressing and holding down the push-button, the push-button LED starts to flash in the colour of the chosen load. This step should be completed with a long press on the PROG & RESET button, both LEDs go out.

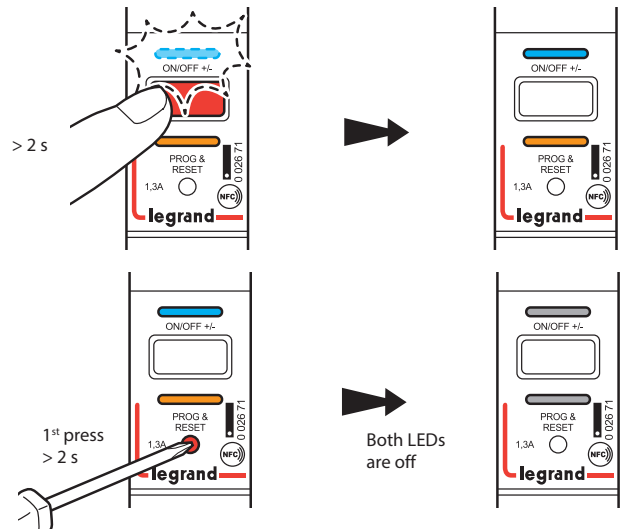

• **Setting the minimum**

The PROG & RESET LED lights up blue to indicate the minimum is being set.

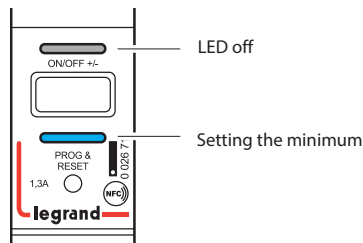

The desired level can be adjusted with long presses on the control unit located in the room. Pressing and holding down the remote control dimmer push-button (ON/OFF) will save the minimum level set.

5. OPERATION (continued)

5.4 Parameter setting (continued)

5.4.2 NFC settings

The different function parameters can be set using NFC after downloading the "Legrand Close Up" or "Close Up for 002671" app from Google Play or legrandoc.com with an NFC-compatible Android mobile phone.

The device must not be connected to the mains during parameter setting.

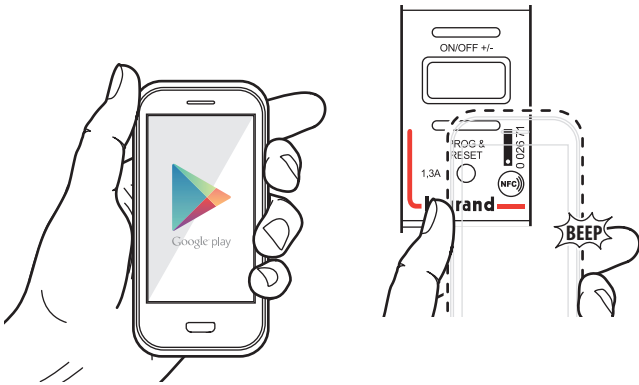

The functions accessible via NFC are as follows:

- Remote control dimmer without dimming level memory
- Step relay
- Remote control dimmer with dimming level memory
- Timer (time modifiable via NFC)
- Preset levels
- Child's room
- Bi-level
- Timer with switch-off warning (time modifiable via NFC)

5. OPERATION (continued)

5.5 NFC settings

After installing the Close Up app, parameter configuration and modification are accessible.

1. Hold the mobile device close to the NFC symbol.

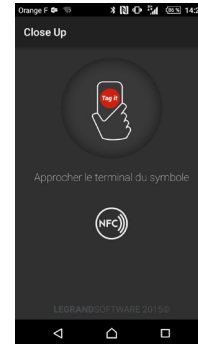

2. The scanned device's data is displayed.

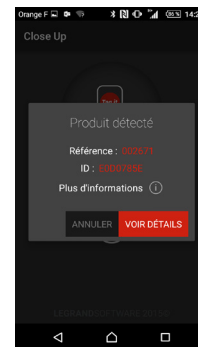

3. Select See details to access the configuration.

This screen provides access to 4 categories:

- Function settings
- Load settings
- Behaviour
- Information

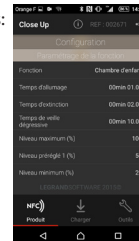

There are three icons at the bottom of the screen:

NFC provides access to the configuration

Load to import the settings

Tools for replacing and duplicating a device (see p5)

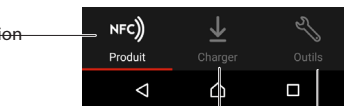

5. OPERATION (continued)

5.5 NFC settings (continued)

5.5.1 Function settings

Used to select the function you wish to assign to the device.

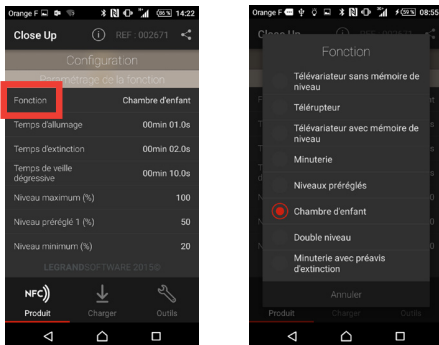

At each function level, different settings are offered.

Example for the Child's room function:



The times for switch-on (or switch-off or gradual dim to standby) are chosen in the menu below:

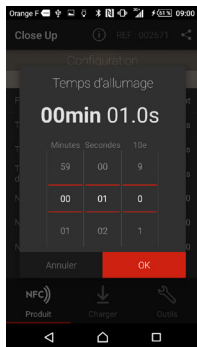

The different levels (maximum, preset and minimum) can be modified.

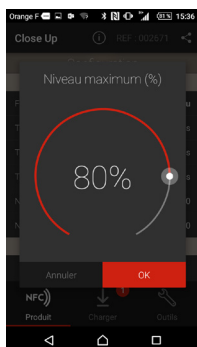

5. OPERATION (continued)

5.5 NFC settings (continued)

5.5.2 Load settings

These settings are used to select the switching type and the load type.

Choice of communication type

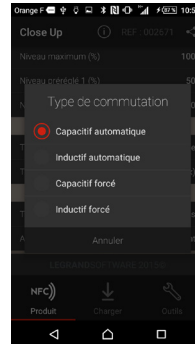

Choice of load type

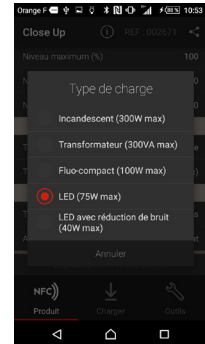

5.5.3 Behaviour

This setting is used to customise the device in terms of setting the push-button time and the device status on power-up.

Setting the push-button time

Setting the device status on power-up

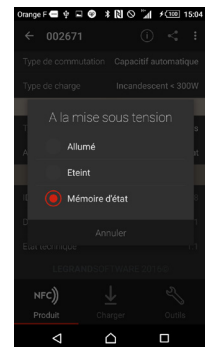
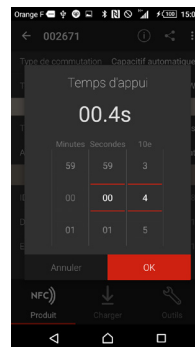

5.5.4 Information

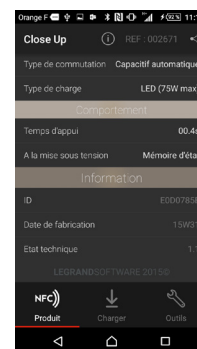

5. OPERATION (continued)

5.5 NFC settings (continued)

5.5.5 Loading the modified settings

The modified settings in the different menus should be loaded and then imported into the device.

The Load icon indicates the number of modified settings:

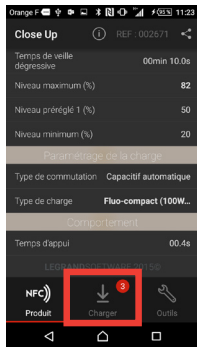

To import these modifications, follow the steps below carefully.

1. Select "Load" and press, then the screen appears.

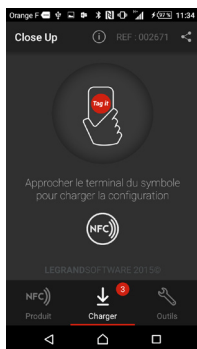

2. Hold the mobile close to the device and the screen indicates that the settings have been saved.

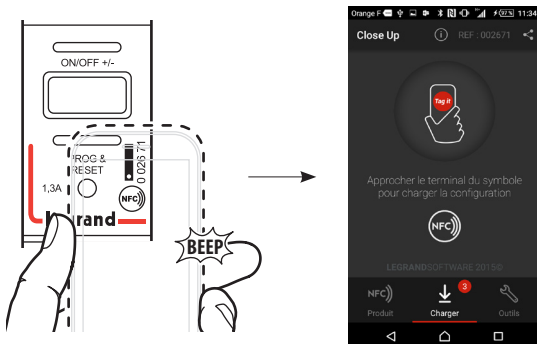

5. OPERATION (continued)

5.5 NFC settings (continued)

5.5.6 Copying a device (not connected to the mains)

This function is used to copy the configuration from one device to another.

1. After selecting "Tools", choose "Copy".

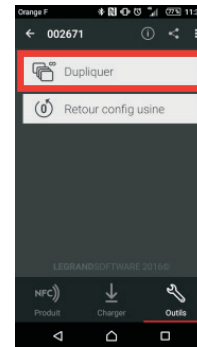

2. Then tag the target device (where the configuration is to be imported) and confirm the target device with OK.



3. Hold the mobile away from the device and then bring it closer to load the configuration, which completes the action.



5. OPERATION (continued)

5.5 NFC settings (continued)

5.5.7 Factory reset

Selecting this function performs a factory reset, and all your saved settings will be erased. The device will have the dimmer without level memory function after this step.

1. After selecting "Tools", choose "Factory reset".

Confirmation is requested before the action continues.

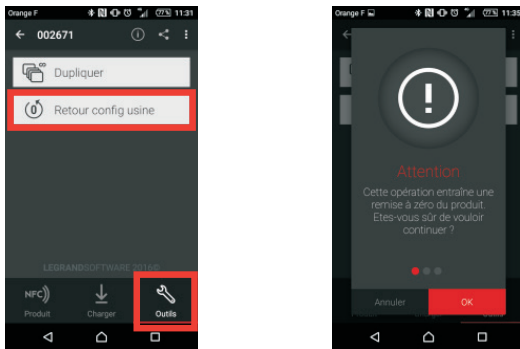

2. Hold the mobile close to the device and the screen indicates that the device has been reset.

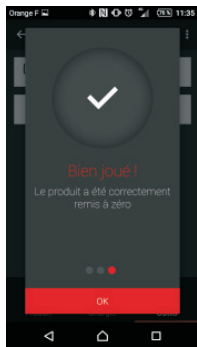

5.5.8 Other functions

After tagging the device, and selecting this icon

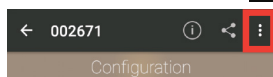

You will be able to access other information, including a help to find out more about how to use the app.

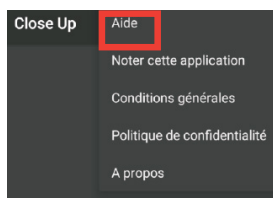

6. CARE

Clean the surface with a cloth.
Do not use acetone, tar-removing cleaning agents or trichloroethylene.
Resistant to the following products: - Hexane (En 60669-1)
- Methylated spirit
- Soapy water
- Diluted ammonia
- Bleach diluted to 10%
- Window-cleaning products

Caution:

Always test before using other special cleaning products.

7. STANDARDS

Installation standards: NFC 15-100
Product standards: NF EN 50 428, IEC 60669-2-1
EN 301 489-1 V1.9.1 (09/2011)
EN 301 489-3 V1.9.2 (08/2013)
NF/EN 62369-1 (08/2009)
EN 300 330-1 V1.8.1 (03/2015)
EN 300 330-2 V1.6.1 (03/2015)

SIMPLIFIED DECLARATION OF CONFORMITY



The undersigned company,
Legrand
declares that radio equipment Cat. No. 0026 71
is compliant with Directive 2014/53/EU.
The full text of the EU declaration of conformity
can be found at the following web address:
www.legrand.com

8. TROUBLESHOOTING**■ 8.1 On the dimmer in the panel**

| PROBLEMS | CAUSES | SOLUTIONS |
|--|--|---|
| The dimmer does not react when the push-buttons on the front are pressed | Device jammed | 1- Check whether mains power is present. 2- Disconnect the mains power. |
| Flashing red ON/OFF LED | Thermal protection | 1- Check and adjust the load total power (overload). 2- Temperature in the enclosure too high: leave 1 empty module on each side of the dimmer. Leave the device to cool (15 min) and press the PROG & RESET button briefly to acknowledge the fault. |
| Flashing red PROG & RESET LED | Voltage or frequency (too low or too high) | Press the PROG & RESET button briefly to acknowledge the fault. |
| Steady red PROG & RESET LED | Overload protection activated | 1- Check and adjust the load total power (overload). 2- Check the loads are working properly (supply the loads directly from the mains). 3- Acknowledge the fault by pressing the PROG & RESET button briefly. |
| Steady red ON/OFF LED | Short-circuit on the load circuit | 1- Check that one of the loads has not been destroyed. 2- Check the wiring. 3- Acknowledge the fault by pressing the PROG & RESET button briefly. |
| The dimmer is stuck on minimum or maximum dimming | Wiring error | Check the push-button wiring. |
| Other fault | General fault | 1- Disconnect the mains power. 2- If this does not work, revert to factory settings. 3- Contact customer service. |
| The push-buttons on the front of the device are not working | The control push-button is wired as normally closed instead of normally open or the control push-button is short-circuited | 1- Rewire or replace the button. 2- If this does not work, please contact customer service. |

8. TROUBLESHOOTING (continued)

■ 8.2 On the dimmer in the panel

| PROBLEMS | CAUSES | SOLUTIONS |
|--|--|--|
| The load does not switch on | Inappropriate setting | 1- Disable the level memory. 2- From the load type mode menu, choose "CFL". 3- If this does not work, please contact customer service. |
| The load flickers when on dimming minimum level | The minimum dimming level is too low for the load | 1- Check whether the load is dimmable.  2- Check that there is not a mixture of load types. 3- Set the dimming minimum. |
| The load flickers permanently | Load type/dimmer setting compatibility problem (CFL mode, leading or trailing mode, etc) | 1- Check whether the load is dimmable.  2- Check that there is not a mixture of load types. |
| The load does not react correctly to the dimming request | Inappropriate setting | 1- Check whether the load is dimmable.  2- Check that there is not a mixture of load types. 3- Configure the dimmer in level memory mode. |
| At switch-on, the load varies for 30 sec | Load teach phase | 1- Set the dimming minimum level. |
| The load does not switch on | General fault | 1- Check mains power is present. 2- Check the load. 3- Check the dimmer status (see dimmer diagnostics table). 4- Check the wiring. |

■ 8.3 On the NFC function

| PROBLEMS | CAUSES | SOLUTIONS |
|---------------------------------------|---|---|
| Communication problem with NFC device | NFC device radio communication not being detected (phone or tablet) | 1- Check whether the "Close Up" app has been installed on the device. 2- Identify the location of the mobile device's NFC antenna (Logo or see manual), and place it on the dimmer NFC logo. 3- Hold the device in contact with the dimmer. 4- The mobile device must not be charging. 5- Remove the mobile device's protective shell. 6- Approach the dimmer quickly, and if communication does not work, go backward and forward to the dimmer several times. Caution: Some NFC devices do not have enough power to work with our product. Caution: After replacing any of the phone components, check that the NFC function is still present (antenna on the battery, protective shell, etc). |

If your problem is still not resolved, please contact customer service.











NB:

All technical information is available at

 www.legrandoc.com











9. APPENDIX

1-module DIN dimmer

| Lamp type | Brand | Photo | Lamp reference/ Year | Number of lamps | Dimmer automatic recognition reading | Conformity of automatic recognition/ Load | Setting(s) to enter for correct temperature rise and dimming | Observations and comments |
|-----------|---|---|---|--|--|---|---|--|
| BULBS | PHILIPS |  | Master LEDbulb MV 18W 1521lm 2015 | 1 to 2 | Leading mode LED with noise reduction (< 40 W) | OK | Check the type of load detected. Set the minimum light level. | The "dimmer without level memory" function is not recommended due to the lamp technology. Dimming range can be set between 15% and 100%. |
| | | 3 to 4 | | Leading mode LED (< 75 W) | | | | |
| | |  | Master LEDbulb MV 17W 1055 lm 2012 | 1 to 2 | Leading mode LED with noise reduction (< 40 W) | OK | Set the minimum light level if necessary. | Dimming range can be set between 15% and 100%. |
| | | 3 | | Leading mode LED (< 75 W) | Dimming range can be set between 20% and 100%. | | | |
| | |  | Master LEDbulb MV 13W 1055lm 2015 | 1 to 3 | Leading mode LED with noise reduction (< 40 W) | OK | Set the minimum light level if necessary. | The "dimmer without level memory" function is not recommended due to the lamp technology. Dimming range can be set between 15% and 100%. |
| | | 4 to 5 | | Leading mode LED (< 75 W) | | | | |
| | |  | Master Ledbulb MV 10W 806lm 2015 | 1 to 4 | Leading mode LED with noise reduction (< 40 W) | OK | Set the minimum light level if necessary. | The "dimmer without level memory" function is not recommended due to the lamp technology. Dimming range can be set between 15% and 100%. |
| | | 5 to 7 | | Leading mode LED (< 75 W) | | | | |
| | |  | Master LEDcluster 4W 250lm 2012 | 1 to 8 | Leading mode LED with noise reduction (< 40 W) | OK | Check the type of load detected. Set the minimum light level if necessary. | Dimming range can be set between 20% and 100%. |
| | |  | Master LEDbulb MV DimTone 8W 470lm 2012 | 1 to 4 | Leading mode LED with noise reduction (< 40 W) | OK | Set the minimum light level if necessary. | Dimming range can be set between 35% and 100%. |
| | | 5 to 8 | | Leading mode LED (< 75 W) | | | | |
| | |  | MASTER Glow LEDbulb MV 8W 470lm 2012 | 1 | Leading mode Compact fluorescent | Not OK | Leading mode + LED with noise reduction (< 40 W). Set the minimum light level if necessary. | Dimming range can be set between 20% and 100%. |
| | |  | Master LED Designer Bulb 7W | 2 | Leading mode LED with noise reduction (< 40 W) | OK | Set the minimum light level if necessary. | Dimming range can be set between 20% and 100%. |
| | |  | | | | | | |
| TOSHIBA |  | LDAEU004C2710D 13W 1060 lm 2015 | 1 to 3 | Leading mode LED with noise reduction (< 40 W) | OK | Set the minimum light level if necessary. | Dimming range can be set between 10% and 100%. | |
| | | | 4 to 5 | Leading mode LED (< 75 W) | | | | |
| |  | LDAEU003C2710D 10.5W 806 lm 2015 | 1 to 3 | Leading mode LED with noise reduction (< 40 W) | OK | Set the minimum light level if necessary. | Dimming range can be set between 10% and 100%. | |
| | | | 4 to 7 | Leading mode LED (< 75 W) | | | | |



9. APPENDIX (continued)

1-module DIN dimmer (continued)

| Lamp type | Brand | Photo | Lamp reference/ Year | Number of lamps | Dimmer automatic recognition reading | Conformity of automatic recognition/ Load | Setting(s) to enter for correct temperature rise and dimming | Observations and comments |
|--|--|---|---|--|--|---|--|---|
| BULBS | OSRAM |  | PARATHOM LED Classic A80 Advanced 12W 2011 | 1 to 3 | Leading mode LED with noise reduction (< 40 W) | OK | Set the minimum light level if necessary. | Adjust the minimum light level if necessary. If the lamps are buzzing, switch to trailing mode. Dimming range can be set between 18% and 100%. |
| | | | | 4 to 6 | Leading mode LED (< 75 W) | | | |
| | |  | Classic A75 Advanced 10W 1055 lm 2015 | 1 to 4 | Leading mode LED with noise reduction (< 40 W) | OK | Set the minimum light level if necessary. | Adjust the minimum light level if necessary. If the lamps are buzzing, switch to trailing mode. Dimming range can be set between 15% and 100%. |
| | | | | 5 to 7 | Leading mode LED (< 75 W) | | | |
| | |  | Classic A60 Advanced 10W 806 lm 2015 | 1 to 7 | Leading mode Transformer + LED | Not OK | 1 to 4 lamps: Leading mode + LED with noise reduction (< 40 W) Set the minimum light level if necessary. 5 to 7 lamps: Leading mode + LED < 75 W Set the minimum light level if necessary. | Adjust the minimum light level if necessary. If the lamps are buzzing, switch to trailing mode. Dimming range can be set between 25% and 100%. |
| | |  | Classic A40 Advanced 6W 470 lm 2015 | 1 to 8 | Leading or trailing mode Transformer + LED | Not OK | 1 to 6 lamps: Leading mode + LED with noise reduction (< 40 W) Set the minimum light level if necessary. 7 to 8 lamps: Leading mode + LED < 75 W Set the minimum light level if necessary. | Adjust the minimum light level if necessary. If the lamps are buzzing, switch to trailing mode. Dimming range can be set between 25% and 100%. |
|  | PARATHOM LED RETROFIT Classic A60 Advanced 8W 806 lm 2015 | 1 to 8 | Leading or trailing mode Transformer + LED | Not OK | 1 to 5 lamps: Leading mode + LED with noise reduction (< 40 W) Set the minimum light level if necessary. 6 to 8 lamps: Leading mode + LED < 75 W Set the minimum light level if necessary. | Adjust the minimum light level if necessary. If the lamps are buzzing, switch to trailing mode. Dimming range can be set between 25% and 100%. | | |
| CANDLE BULBS | PHILIPS |  | Novallure 3W 136 lm 2011 | 1 to 2 | Leading mode Compact fluorescent | Not OK | Leading mode + LED with noise reduction (< 40 W) Set the minimum light level if necessary. | Dimming range can be set between 20% and 100%. |
| | TOSHIBA |  | LDC004D2760DEU 4.5W 270 lm 2015 | 1 to 8 | Leading mode LED with noise reduction (< 40 W) | OK | Set the minimum light level if necessary. | Dimming range can be set between 15% and 100%. |
| SPOTLIGHTS | PHILIPS |  | MASTER LEDspot GU10 7W 2012 | 1 to 6 | Leading mode LED with noise reduction (< 40 W) | OK | Set the minimum light level if necessary. | Lamp(s) flicker between 30 and 40% dimming. Dimming range can be set between 20% and 100%. |
| | | | | 7 to 8 | Leading mode LED (< 75 W) | | Check the type of load detected. Set the minimum light level if necessary. | |
| | |  | MASTER LEDspot GU10 8W DimTone 2012 | 1 to 5 | Leading mode LED with noise reduction (< 40 W) | OK | Check the type of load detected. Set the minimum light level if necessary. | Lamp(s) flicker at 20% dimming. Dimming range can be set between 20% and 100%. |
| | |  | Master LEDSPOT 25D PAR38 13W 1000lm 2015 | 1 to 3 | Leading mode LED with noise reduction (< 40 W) | OK | Set the minimum light level if necessary. | Dimming range can be set between 20% and 100%. If the lamps are buzzing, switch to trailing mode. |
| | | | 4 to 5 | Leading mode Compact fluorescent or LED (< 75 W) | Not OK | Leading mode + LED < 75 W Set the minimum light level if necessary. | | |
| | OSRAM |  | PARATHOM PRO LED 8W GU10 600 cd /2012 | 1 to 2 | Leading mode LED with noise reduction (< 40 W) | OK | Check the type of load detected. Set the minimum light level if necessary. | Lamp(s) flicker slightly at 20% dimming. Dimming range can be set between 20% and 100%. |

9. APPENDIX (continued)

1-module DIN dimmer (continued)

| Lamp type | Brand | Photo | Lamp reference/ Year | Number of lamps | Transformer reference | Dimmer automatic recognition reading | Conformity of automatic recognition/ Load | Setting(s) to enter for correct temperature rise and dimming | Observations and comments | | | |
|--------------------------------------|--|---|---|--------------------|---|---|---|---|---|--|---|--|
| LOW VOLTAGE | PHILIPS |  | MASTER LEDspot MR16 6.5W 390 lm 2015 | 1 to 4 max | OSRAM HALOTRONIC HTM70 (20-70W) | Leading mode or trailing mode Compact fluorescent or Transformer | Not OK | Leading mode + Transformer Set the minimum light level if necessary. | Dimming range can be set between 15% and 100%. | | | |
| | | | | 2 min to 8 max | OSRAM HALOTRONIC HTM105 (35-105W) | Leading mode LED with noise reduction (< 40 W) or LED (< 75 W) | | | Dimming range can be set between 20% and 100%. | | | |
| | | | | 2 min to 6 | OSRAM HALOTRONIC HTM150 (50-150W) | Leading mode LED with noise reduction (< 40 W) | | | Dimming range can be set between 20% and 100%. If the transformer is buzzing, switch to trailing mode. | | | |
| | | | | 7 to 18 max | | | Trailing mode Transformer | OK | Set the minimum light level if necessary. | Dimming range can be set between 20% and 100%. | | |
| | | | | 1 to 6 max | PHILIPS ET-E60 (20-60W) | Leading mode Compact fluorescent or LED with noise reduction (< 40 W) | Not OK | Leading mode + Transformer Set the minimum light level if necessary. | Dimming range can be set between 15% and 100%. | | | |
| | | | | | PHILIPS CERTALINE 60W (20-60W) | Leading mode or trailing mode LED with noise reduction (< 40 W) or transformer | | | Dimming range can be set between 15% and 100%. If the transformer is buzzing, switch to trailing mode. | | | |
| | | | | 1 to 4 max | LEGRAND TMDO 50 45 W FERRO | Leading mode Transformer | OK | Set the minimum light level if necessary. | | | | |
| | | | | 1 to 6 max | NELSON MTECOUGAR60 (20-60W) | Leading mode or trailing mode LED with noise reduction (< 40 W) | Not OK | Leading mode + Transformer Set the minimum light level if necessary. | Dimming range can be set between 15% and 100%. | | | |
| | | | | | JCC JC4018 (20-60W) | Leading mode LED with noise reduction (< 40 W) or transformer | | | | | | |
| | | | | OSRAM |  | PARATHOM MR16 35 5.9W 350lm 2015 | 1 to 5 max | OSRAM HALOTRONIC HTM70 (20-70W) | Leading mode or trailing mode LED with noise reduction (< 40 W) or Transformer | Not OK | Leading mode + Transformer Set the minimum light level if necessary. | Dimming range can be set between 20% and 100%. |
| | | | | | | | 2 min to 8 max | OSRAM HALOTRONIC HTM105 (35-105W) | Leading mode LED with noise reduction (< 40 W) or LED (< 75 W) | | | |
| | | | | | | | 4 min to 8 | OSRAM HALOTRONIC HTM150 (50-150W) | Leading mode LED with noise reduction (< 40 W) | | | |
| | | | | | | | 9 to 12 max | | Leading mode LED (< 75 W) or transformer | | | |
| | | | | | | | 1 to 6 max | PHILIPS ET-E60 (20-60W) | Leading mode Compact fluorescent or Transformer | OK | Set the minimum light level if necessary. | Dimming range can be set between 15% and 100%. |
| PHILIPS CERTALINE 60W (20-60W) | Leading mode LED with noise reduction (< 40 W) | Dimming range can be set between 15% and 100%. If the transformer is buzzing, switch to trailing mode. | | | | | | | | | | |
| 1 to 5 max | LEGRAND TMDO 50 45 W FERRO | Leading mode Transformer | OK | | | | Set the minimum light level if necessary. | Dimming range can be set between 15% and 100%. | | | | |
| 1 to 6 max | NELSON MTECOUGAR60 (20-60W) | Leading mode or trailing mode LED with noise reduction (< 40 W) | Not OK | | | | Leading mode + Transformer Set the minimum light level if necessary. | Dimming range can be set between 20% and 100%. | | | | |
| | JCC JC4018 (20-60W) | Trailing mode Transformer | | | | | | OK | Set the minimum light level if necessary. | | | |