

Addressable Self-testing self-contained emergency home lighting unit

Cat. No: 0 626 50

www.legrandoc.com

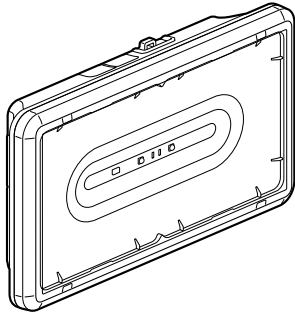

CONTENTS	Page
1. Description	1
2. Installation	2
3. Operation	3
4. Connection	14
5. Maintenance	22
6. Compliance and approvals	23
7. Equipment and accessories	23

1. DESCRIPTION

IP 43 - IK 07 self-testing self-contained emergency home lighting unit
 8 lm - 5 h
 Class II:
 Consumption: 0.5 W - 0.7 VA

• As-shipped product

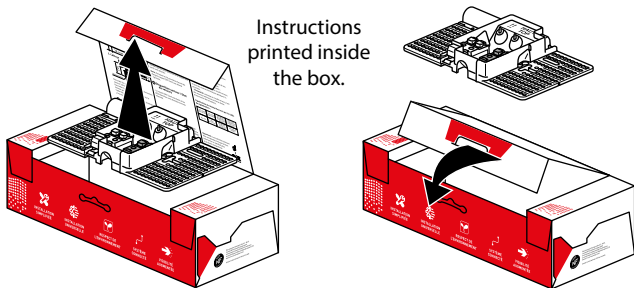
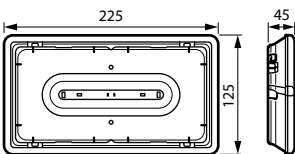

Plate delivered not connected. The box can be re-closed after the plate has been used.

Supplied without signalling label

• Dimensions



Weight of product in packaging: 447 g.
 Volume: 1.9 dm³.

• Technical characteristics

Product for surface mounting on walls or ceilings.
 Emergency home lighting unit.
 Rated flux at 5 hours: 8 lumens.
 Standby power: 5 hour (to ensure this duration, the standard requires a minimum standby power of 7 hour 30 minutes when new).
 Conforming to standards: NF C 71-805 and NF EN 60598-2-22
 NF C 71-820 + NF 413.
 Awarded the "NF AEAS performance SATI" and NF environment quality marks.

• Technical characteristics (continued)

Class II:
 Remote control for setting to rest mode during intentional mains power breaks.
 Remote control input terminals protected against connection errors.
 230 V \sim - 50/60 Hz power supply.
 Fitted with large-capacity automatic connection terminals (2 x 2.5 mm²).
 Usage temperature: -5°C to +35°C

• Materials

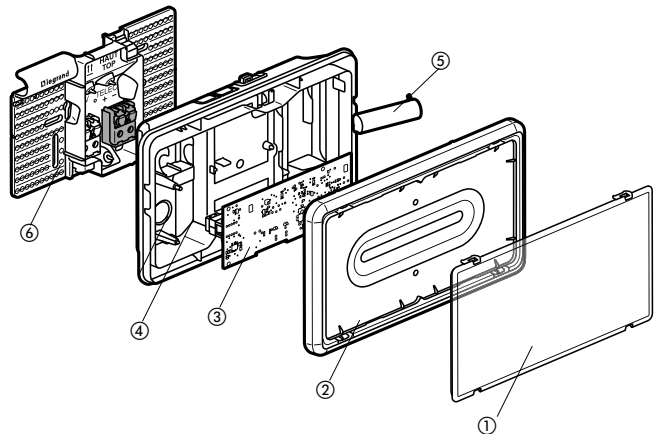

- Class II plastic casing:
- ① Diffuser: clear polycarbonate, self-extinguishing 850°C 30 s.
 - ② Reflector: white polycarbonate, self-extinguishing 850°C 30 s
 - ③ Circuit board.
 - ④ Base: white polycarbonate, self-extinguishing 850°C 30 s.
 - ⑤ Battery.
 - ⑥ Plate incorporating the weatherproofing membranes: polypropylene + SEBS, self-extinguishing 850°C 30 s.

All plastic parts weighing more than 50 g are marked with their material type so that the materials can be recycled at the product's end of the life.

• Calorific value

Thermal load of the plastic components of the casing: 10.2 MJ.

2. INSTALLATION

• New installation

Plate dimensions.

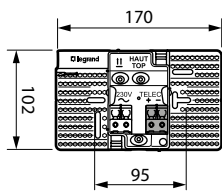

REMOTE CONTROL - Connection terminals: no direction of connection with Legrand remote controls.
Terminal capacity: 2 x 2.5 mm².

• Fixing the plate

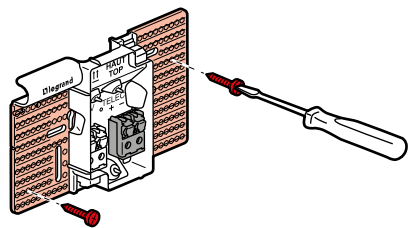
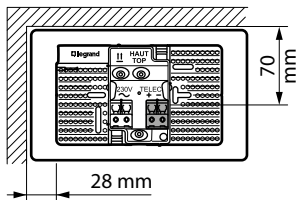

Can be attached over the whole marked area.

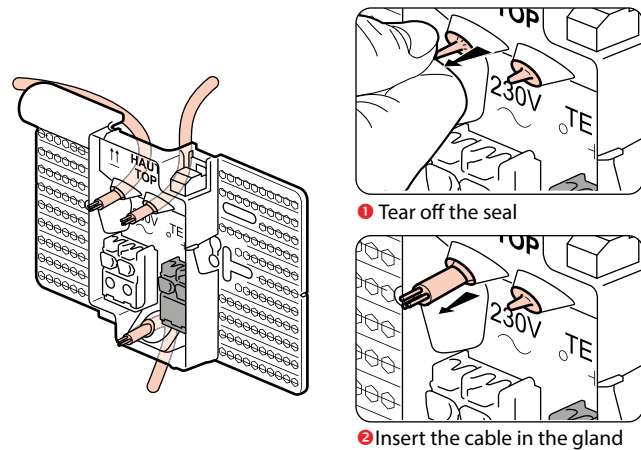

• Fixing the plate on a flush-mounting box

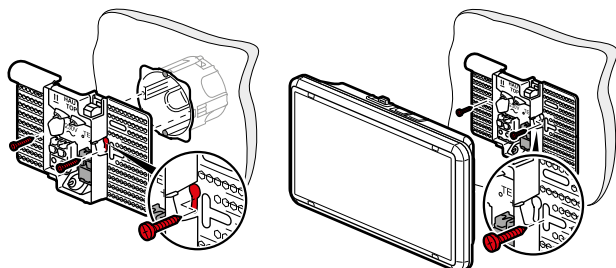

1 Positioning the 2 screws in the flush-mounting box.

2 Fixing in the wall with 2 additional screws.

2. INSTALLATION (continued)

• Installation level with the ceiling

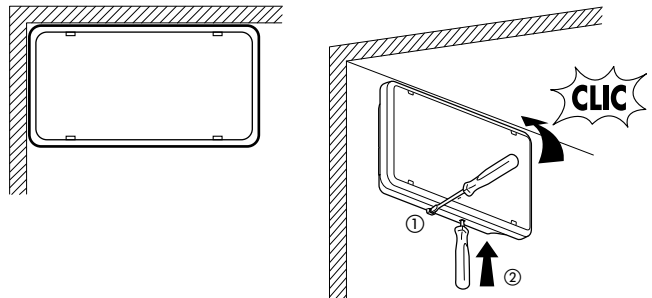

⚠ Can be unlocked by pushing a screwdriver right through to the back of the unit (minimum blade length 110 mm).

• Replacing an existing unit with a 0 625 50 unit while keeping the old plates:

* For plates from 1998 to 2010 you should turn the unit upside down and reposition the pictogram, in which case the unit protection rating becomes IK 05.

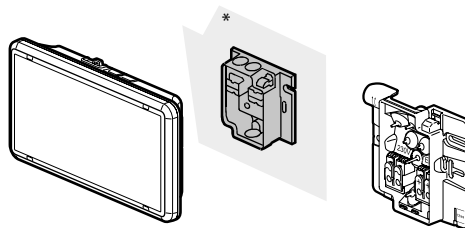

Attach a maintenance label Cat. No. 0 609 00 and write the commissioning date on it.

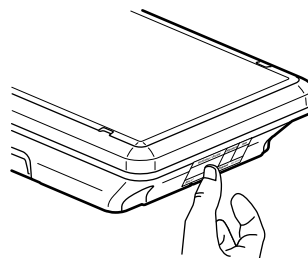

3. OPERATION

This self-testing addressable self-contained emergency lighting unit incorporates two operating modes: self-testing mode and addressable mode.

Self-testing mode

This lighting unit is factory-configured in self-testing mode, and can therefore be used in this mode without any alteration.

Addressable mode

This lighting unit can also be used on an addressable system. For this it must be addressed using configuration tool Cat. No. 0 882 40 in accordance with the procedure described in the "Addressing lighting units" section. It is then possible to control it remotely using the central control panel Cat. No. 0 626 00 (for more detailed information, see the addressable self-contained emergency lighting units installation manual supplied with Cat. No. 0 626 00).

■ 3.1 Switch-on/standby state

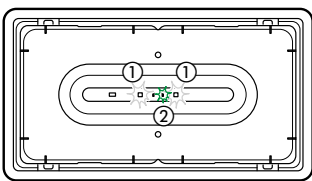

The 2 white standby LEDs come on ①
The green unit status LED comes on (flashing while the batteries are charging; 24 hours max.) ②

Exception

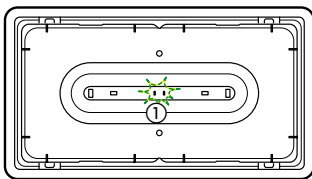

Both LED indicators flashing green/yellow ①
- unit not addressed/lighting unit voltage present
- unit addressed/BUS voltage not present

■ 3.2 Mains supply break/emergency operation

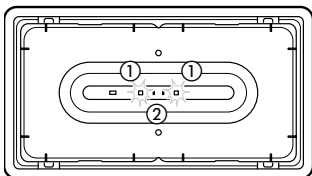

The emergency LEDs come on (45 lm) ①
The green unit status LED goes off ②

3. OPERATION (continued)

■ 3.3 Setting to rest mode using remote controls 0 625 20/21 and 0 039 00 /01

After the normal lighting is switched off intentionally:

Pressing the Off button  sets the unit to rest mode to prevent the battery discharging, in compliance with regulation EC14.

Normal lighting switched back on:

The unit automatically returns to standby.

■ 3.4 Automatic checking of the unit status (self-testing system)

This unit automatically checks its operating status.







Once a week:

Switches to emergency state and tests the light source for 15 s.



Once every three months:

Switches to emergency state and tests the light source and the standby battery power time.

3.4.1 Result of the automatic checks

LEDs	Luminaire OK	Battery fault	Other fault(s)
Green	 (steady or flashing)		
Yellow		 (steady)	 (rapid flashing)

The time of the tests is set at the time the unit is first switched on. The day of the test is chosen randomly in order to ensure that a minimum number of units is tested at the same time.

The time at which all the units are tested can be changed to the required time by simultaneously pressing the On  and Off  buttons on the remote control.

3.4.2 Stopping a test in progress

If a manual autonomy test hinders operation, it can be stopped immediately. Press the Off button  on the remote control Cat. No. 0 625 20/21 or 0 039 00/01. The test is stopped and postponed until the following day.

3. OPERATION (continued)

3.5 Interrogating the unit

Infrared configuration tool Cat. No. 0 882 40 with the Close Up app is used to view and modify the emergency lighting unit parameters.



The screenshots change as and when the Close Up app is updated.

3.5.1 Viewing information

Step 1: After interrogating the desired unit, the following information is accessible:

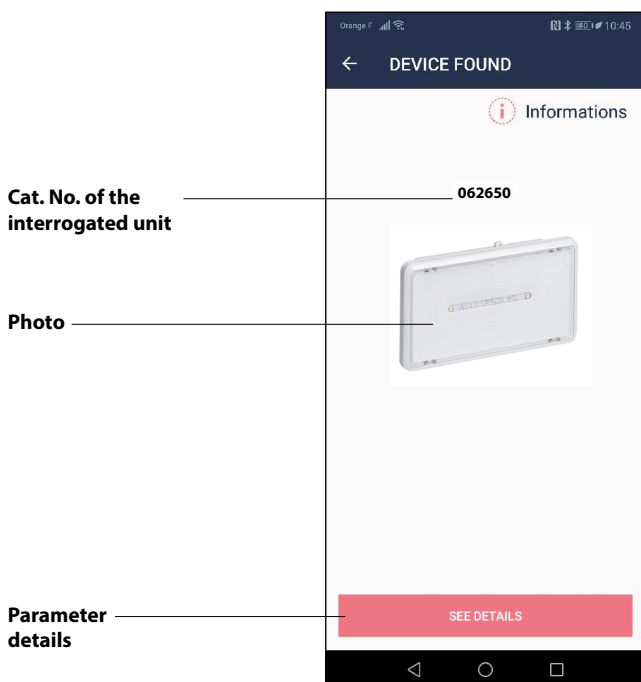

3.5 Interrogating the unit (continued)

3.5.1 Viewing information (continued)

Step 2: Click to access the technical documentation



Link back to www.legrandoc.com to view all the product documentation.

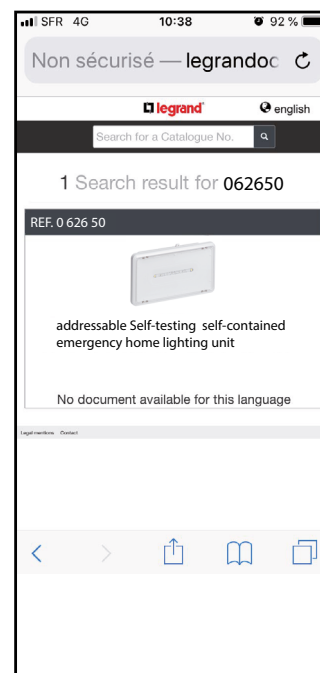

3. OPERATION (continued)

■ 3.5 Interrogating the unit (continued)

3.5.1 Viewing information (continued)

Step 3: Click "SEE DETAILS" to access the full list of parameters and additional information. During this step you must hold the configuration tool facing the interrogated unit, the parameter loading is then visible on the phone screen.

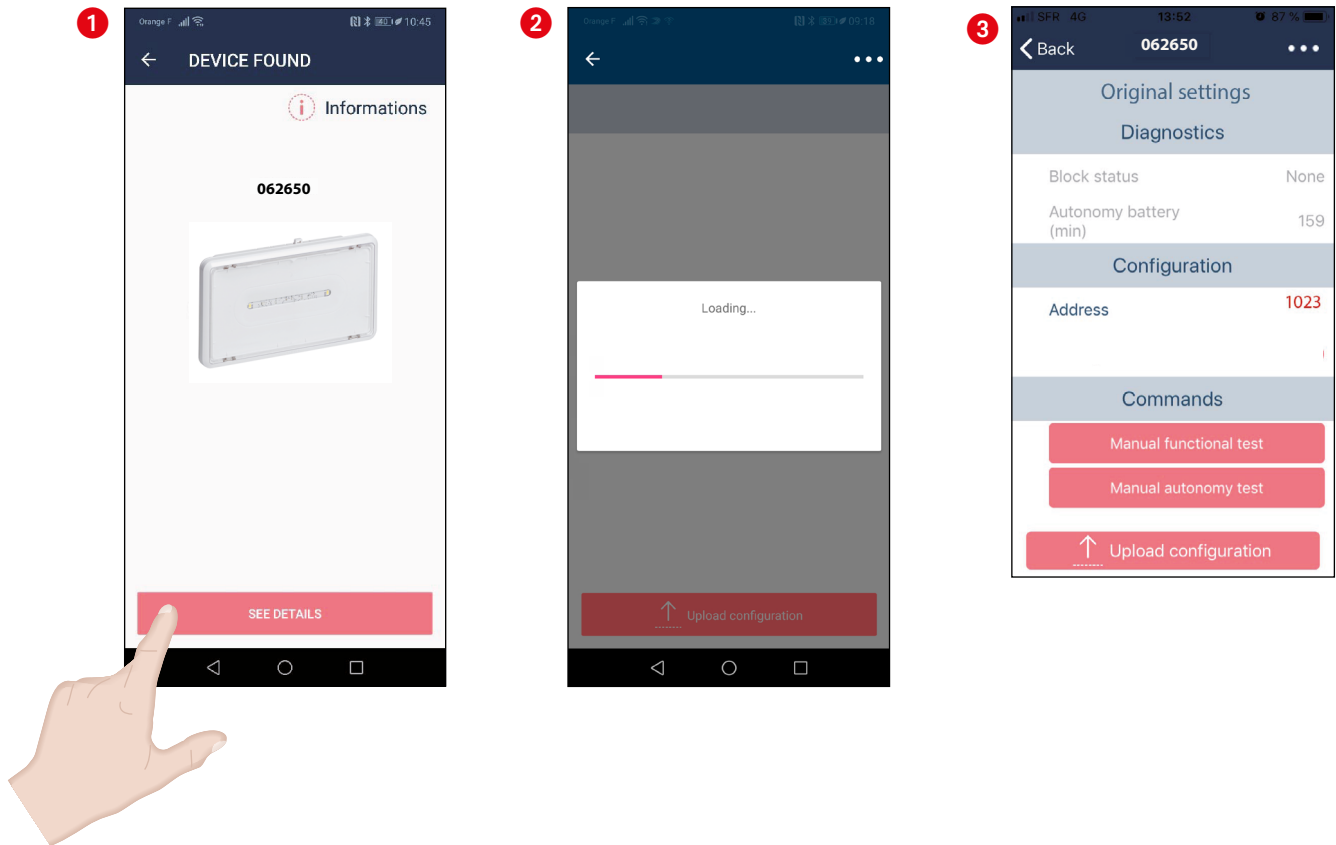

Step 4: In the "Diagnostics" part the user can see if the unit is faulty and the battery autonomy.

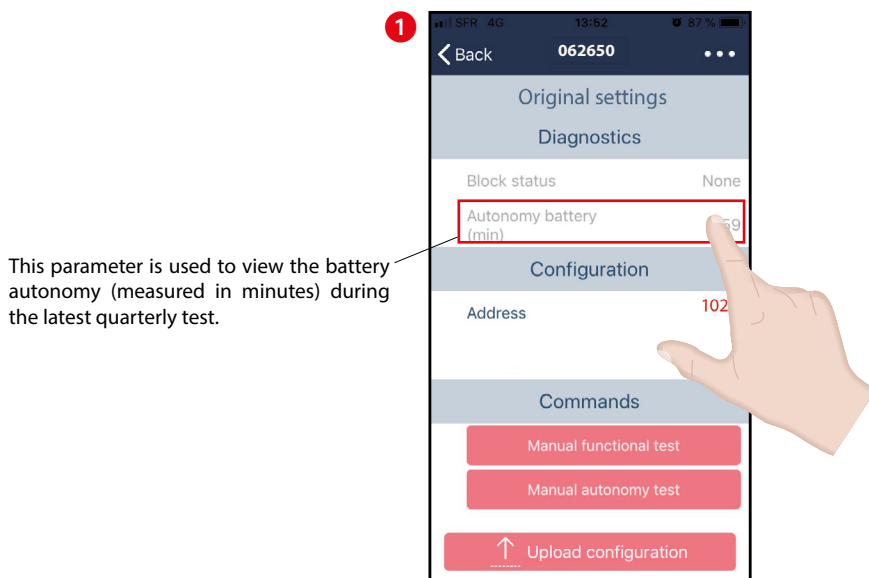

3. OPERATION (continued)

■ 3.5 Interrogating the unit (continued)

3.5.1 Viewing information (continued)

Step 5: In the "Commands" part, clicking on "Manual functional test" or "Manual autonomy test" starts the functional and autonomy tests. These will only start running if the unit is sufficiently charged. These tests are immediate, they are not postponed.

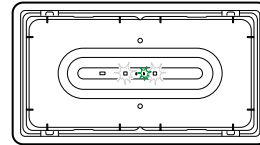
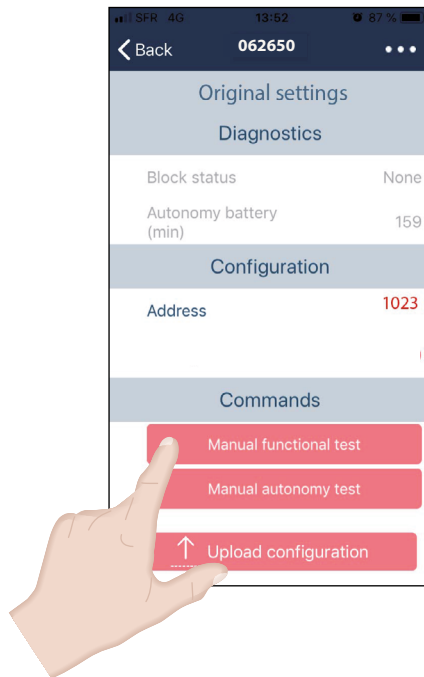

After clicking on manual functional test or manual autonomy test, the result can be viewed on the unit:

- For the manual functional test the unit comes on in emergency mode for 15 seconds
- For the manual autonomy test, the unit stays on until its battery has fully discharged

3.5.2 Assigning the sequence number in the queue

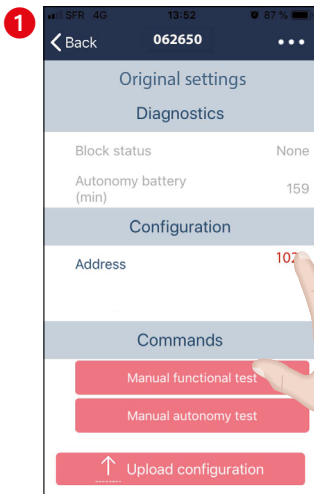

In the "Configuration" part, click to the right of "Block position" on the number.

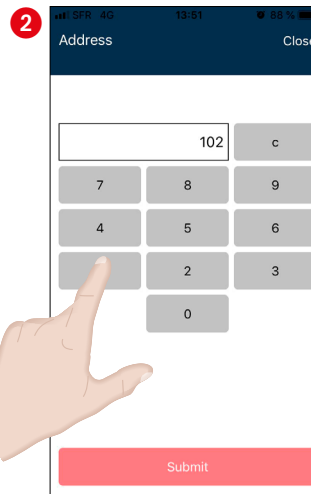

Enter the unit number in the queue.

3. OPERATION (continued)

3.5 Interrogating the unit (continued)

3.5.2 Assigning the sequence number in the queue (continued)

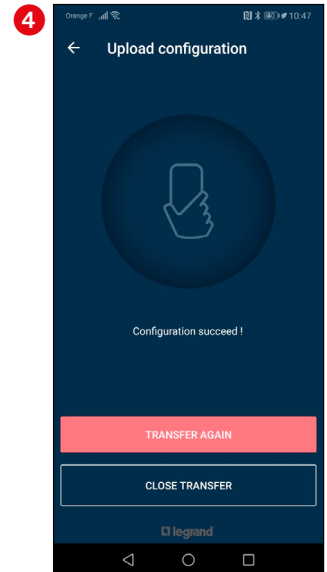
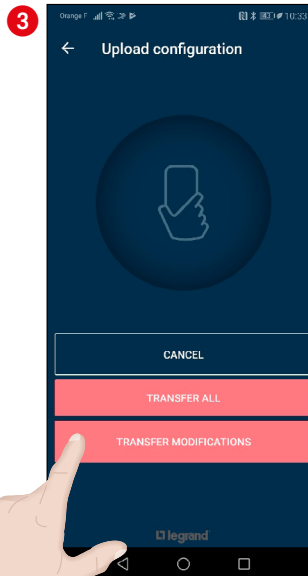

Aim the configuration tool at the unit to confirm this action.

3.5.3 Changing a unit address

After interrogating the unit (see section 3.6.1 Viewing information), it can be addressed by performing the steps below.

Note: Address 1023 corresponds to the standard self-testing function.

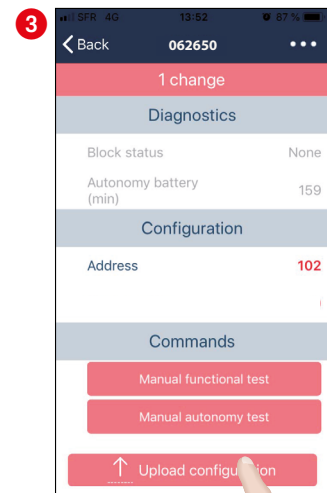
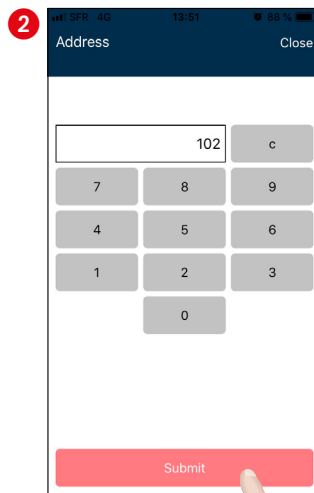
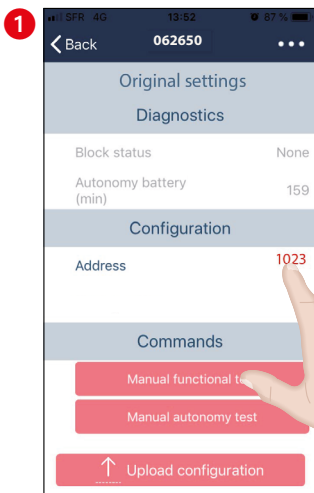

To assign an address to the unit, click to the right of "Address".

In this step you enter the number you wish to assign to the unit address, then confirm.

Next, save this change by clicking "Upload configuration".

3. OPERATION (continued)

■ 3.5 Interrogating the unit (continued)

3.5.3 Changing a unit address (continued)



Aim the configuration tool at the unit to confirm this action.

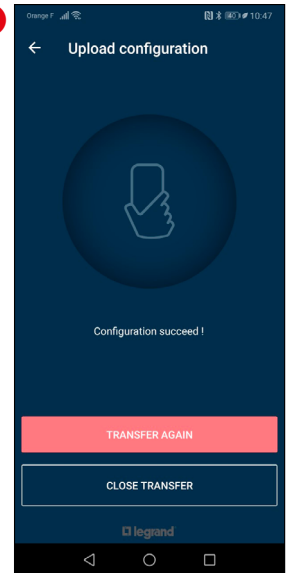
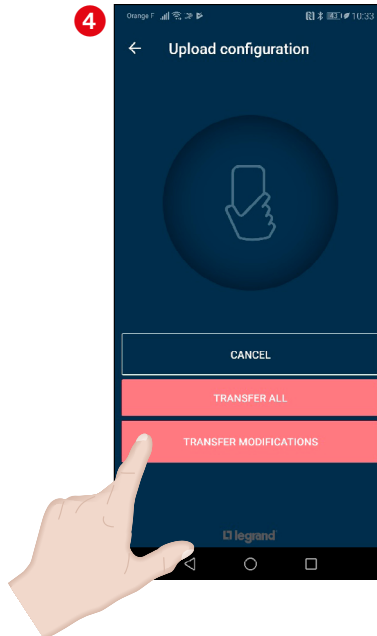

The address has been saved.

■ 3.6 Addressing units

If you decide not to interrogate the unit first, there are two different addressing methods, by direct addressing or from a list. To access unit addressing, follow the steps detailed below:

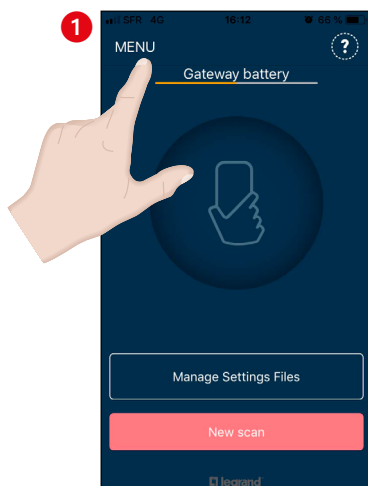

On the home screen click **MENU**

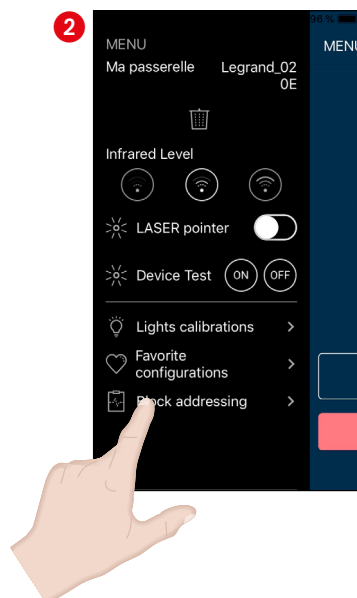

Click "**Block addressing**".

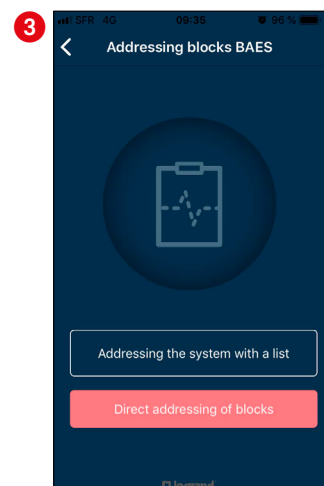

In this step there are 2 possible options:
 - Addressing the system using a list (with .csv file)
 - Addressing units directly

3. OPERATION (continued)

■ 3.6 Addressing units (continued)

3.6.1 Direct addressing

Assigning an address

After clicking "Direct addressing of blocks", click "Block address" to assign an address.



Assign an address number, then complete the action with "Assign the blok address".

Deleting an address

To delete the unit address, simply click "Delete block address".



3. OPERATION (continued)

■ 3.6 Addressing units (continued)

3.6.2 Addressing the system using a list

After clicking "Addressing the system using a list", there are 2 options:

- Resume addressing

or

- Upload interface addressing

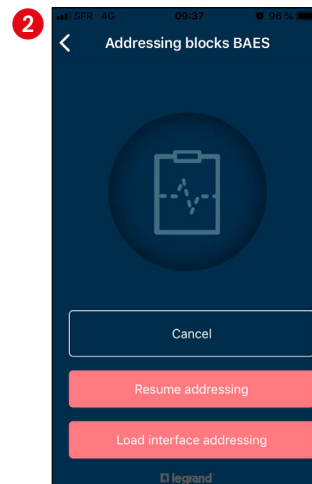
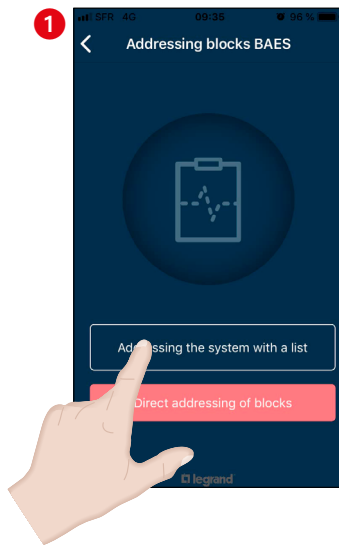

After clicking "**Upload interface addressing**", you need to attach the .csv file for the relevant interface.

For more information about creating the .csv file, see the addressable self-contained emergency lighting units installation manual.

3. OPERATION (continued)

3.6 Addressing units (continued)

3.6.2 Addressing the system using a list (continued)

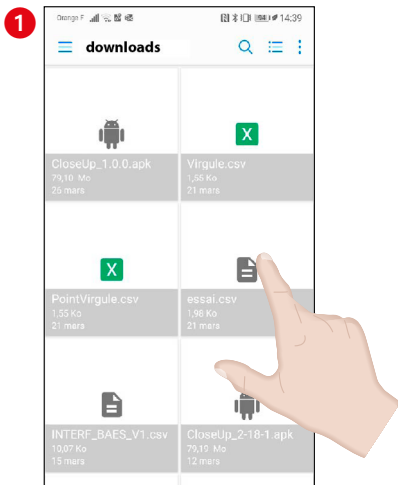

Select the file.

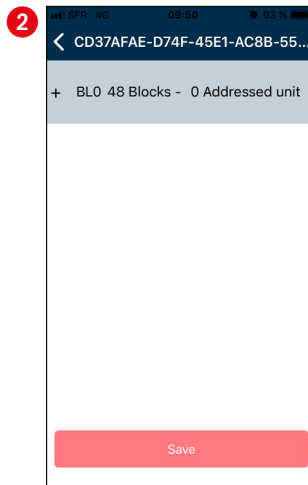

The file is imported and the content can be accessed by clicking on

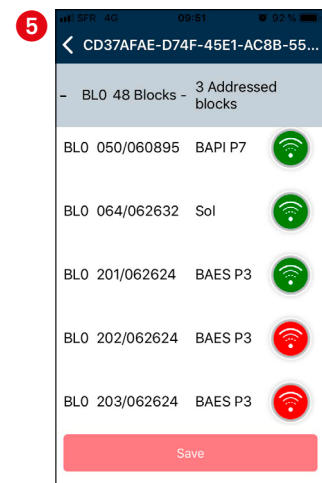
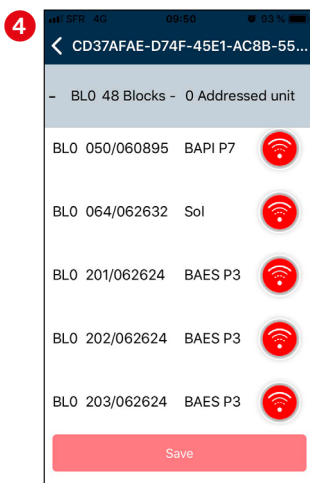
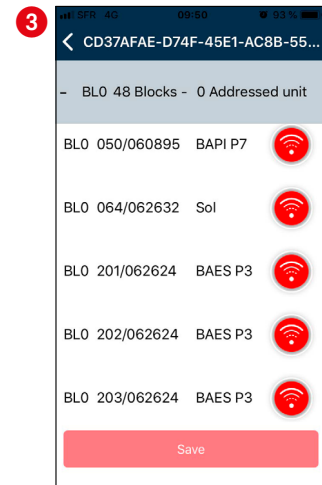

To address the units, click on the icon



The icon for the unit concerned turns green if it has been addressed correctly.

3. OPERATION (continued)

■ 3.6 Addressing units (continued)

3.6.2 Addressing the system using a list (continued)

⚠ If the unit doesn't respond or hasn't received the addressing information, the following message appears:

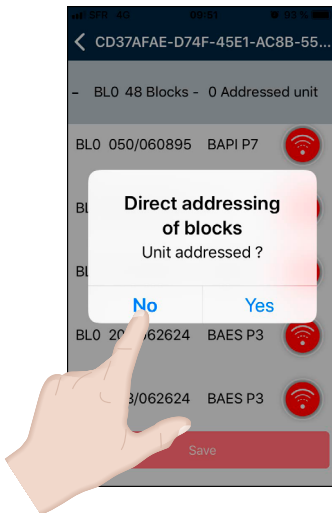

Click "No", then try again.

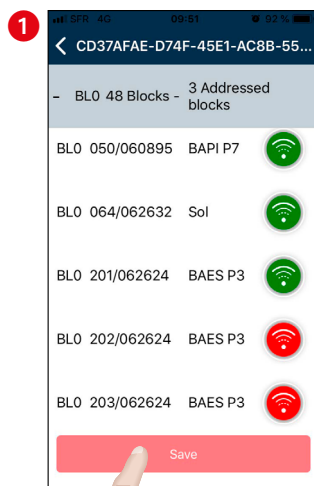

Then save this file listing the addressed units: click "Save".

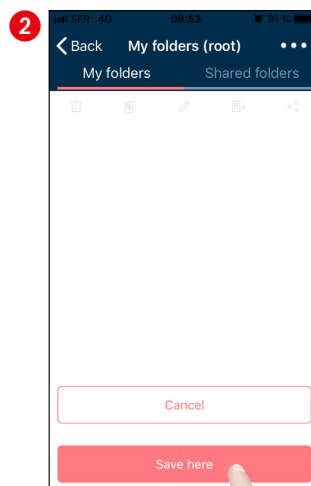

Then click "Save here" and give a name to this file listing the addressed units, then "Save".

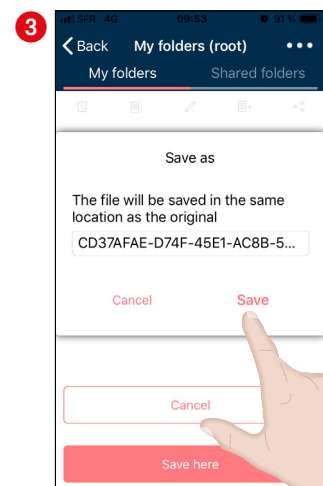

3. OPERATION (continued)

■ 3.6 Addressing units (continued)

3.6.2 Addressing the system using a list (continued)

To resume addressing

Click "Resume addressing" to continue addressing and view which units have already been saved.

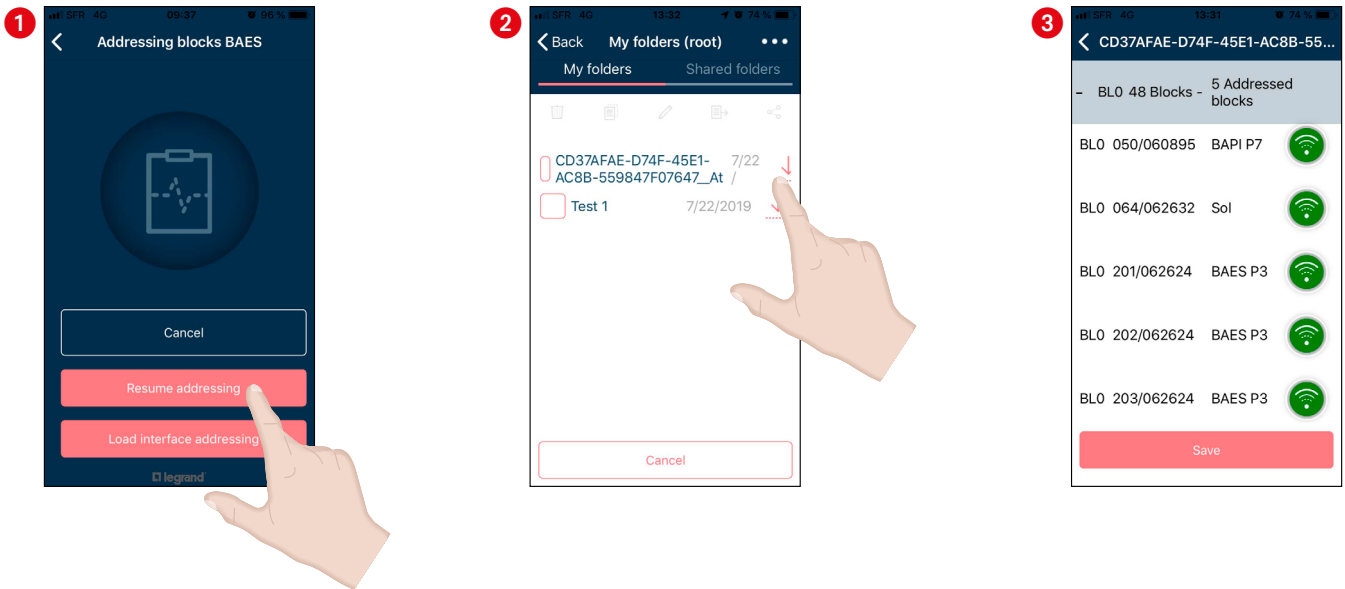

Select the icon ↓ and you can then work on the relevant interface file by repeating the steps described earlier.

Deleting a unit address from an interface

From the screen displaying the interface details, it is possible to delete the addresses of units with green dots.

Press the icon  and the dot next to the unit concerned turns back to red



4. CONNECTION

■ 4.1 Connecting mains power to the self-contained units

Art. EC 12 section 3 of the safety regulations.

The branch supplying a unit must be joined downstream of the protection device and upstream of the normal lighting control device for the room or exit route in which the unit is installed.

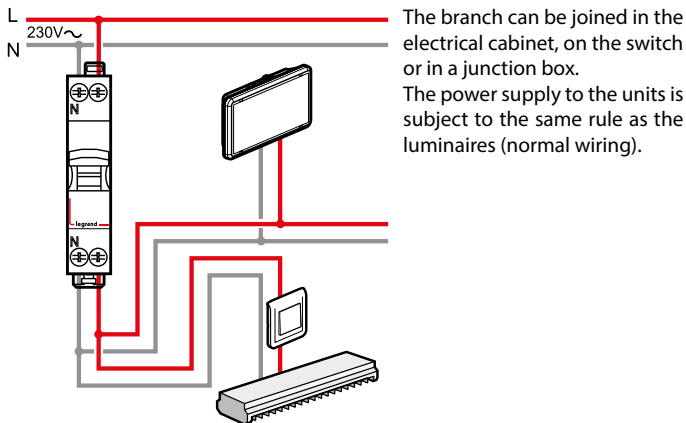

Standard NF C 15-100 permits, in article 521.6.1, the mains supply connection and the remote control to be in the same cable or conduit.

Tap-off from one unit to another is permitted as long as the protection device for the line on which they are connected is 16 A or more.

The remote control polarity may not be correct on this self-contained emergency lighting unit if a Legrand remote control Cat. No. 0 625 20 or 0 625 21 or previous generation Cat. No. 0 039 00 or 0 039 01 is used. If another remote control is used, the correct polarity must be followed when wiring, and the switch-on or switch-off command must be maintained for at least 2 seconds.

Remote controls Cat. Nos. 0 625 20/21 have 3 operating modes:

- **Standard mode:** up to 600 products
- **Supervised mode:** used for surveillance of installations with up to 63 products max.
- **Connected supervised mode:** supervised mode with remote management using the legrandERPconnecté app.

i For more information, see technical data sheet for connected remote control Cat. No. 0 625 20.

4. CONNECTION (continued)

■ 4.2 Remote control for setting to rest mode

Installation (in standard mode) comprising more than 600 self-contained emergency lighting units:

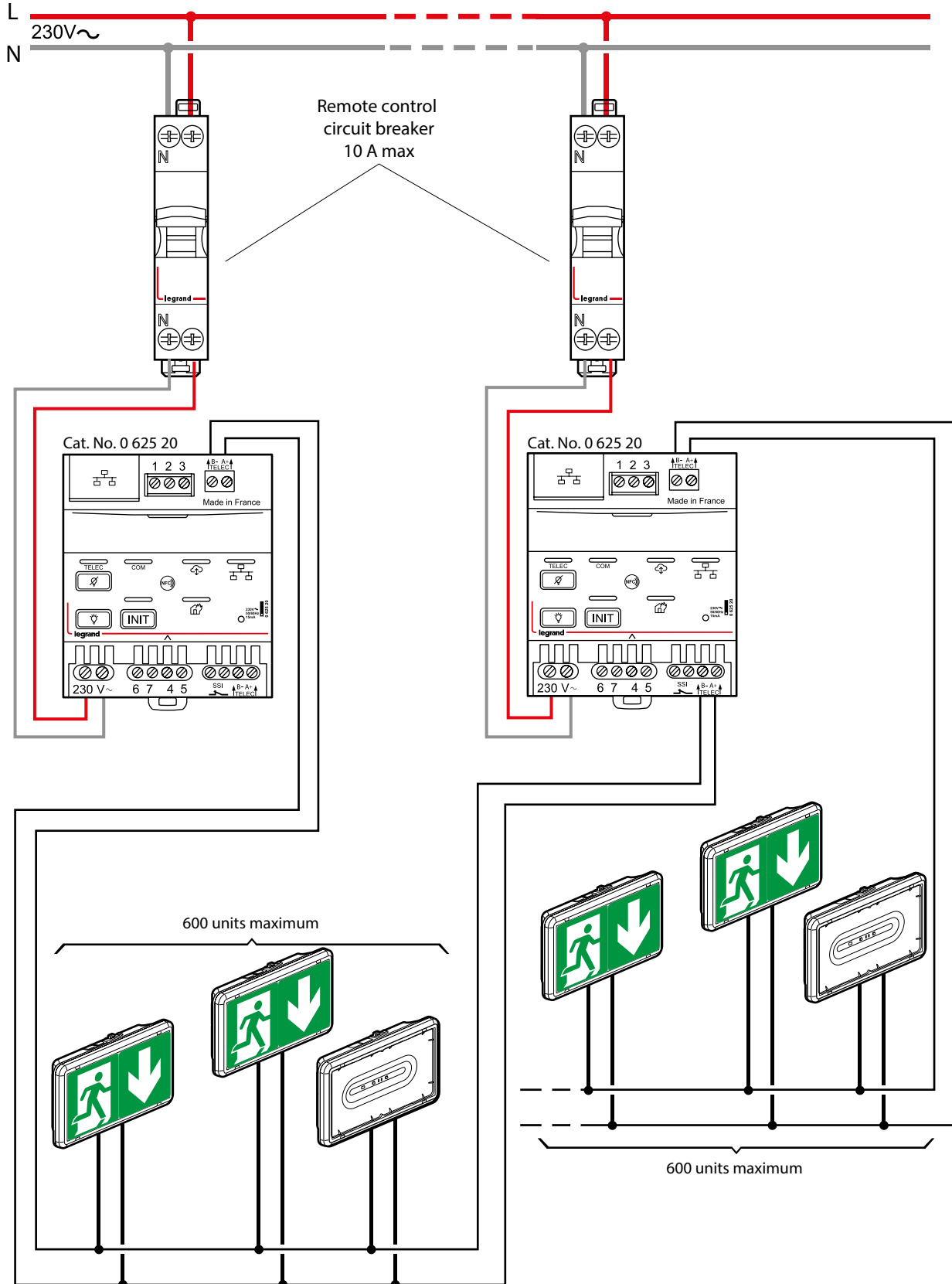

4. CONNECTION (continued)

4.2 Remote control for setting to rest mode (continued)

Setting an installation (in standard mode) comprising several operating zones to rest mode, zone by zone:

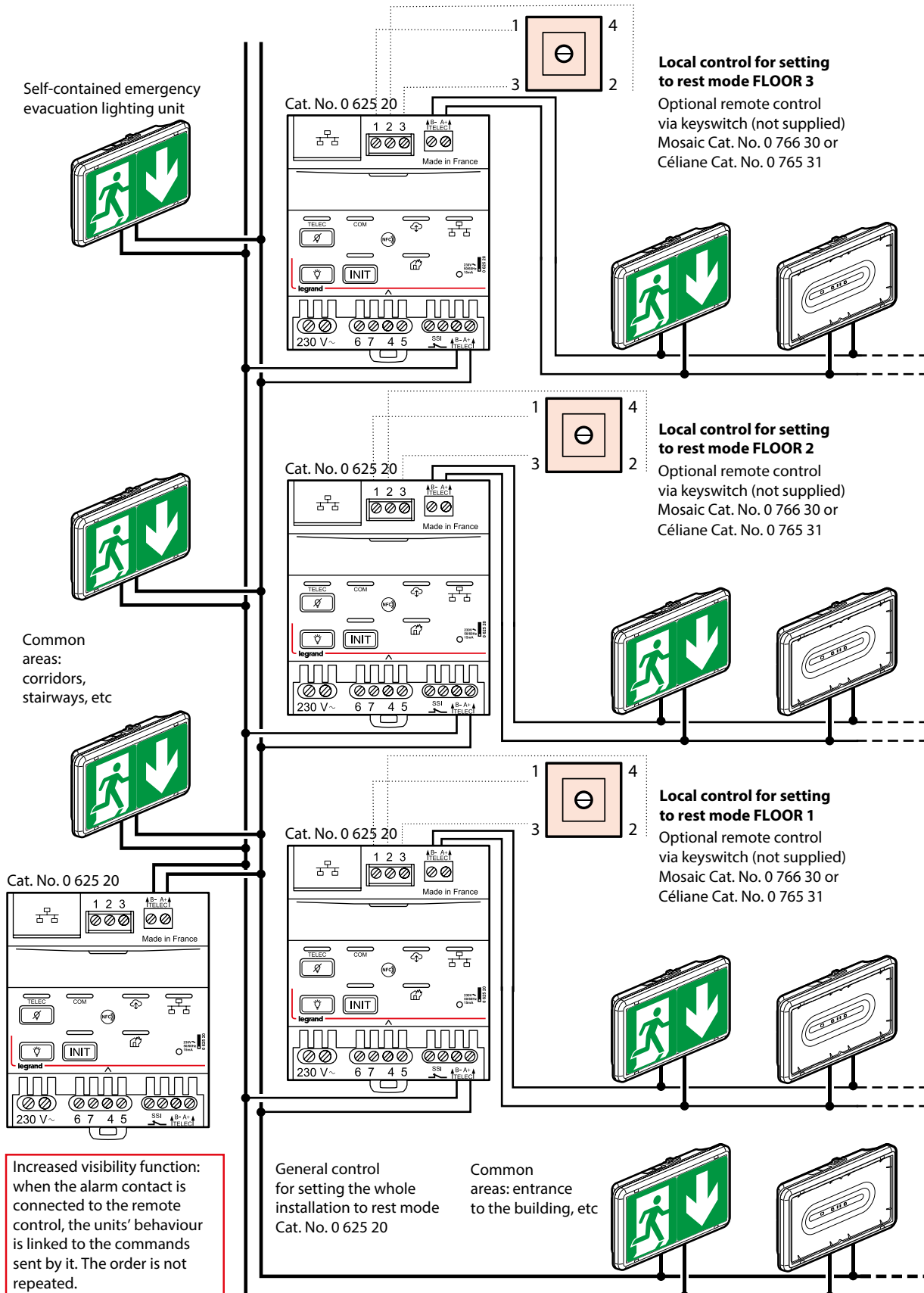

4. CONNECTION (continued)

4.2 Remote control for setting to rest mode (continued)

Setting an installation (in supervised mode and in connected supervised mode) of more than 63 products to rest mode:

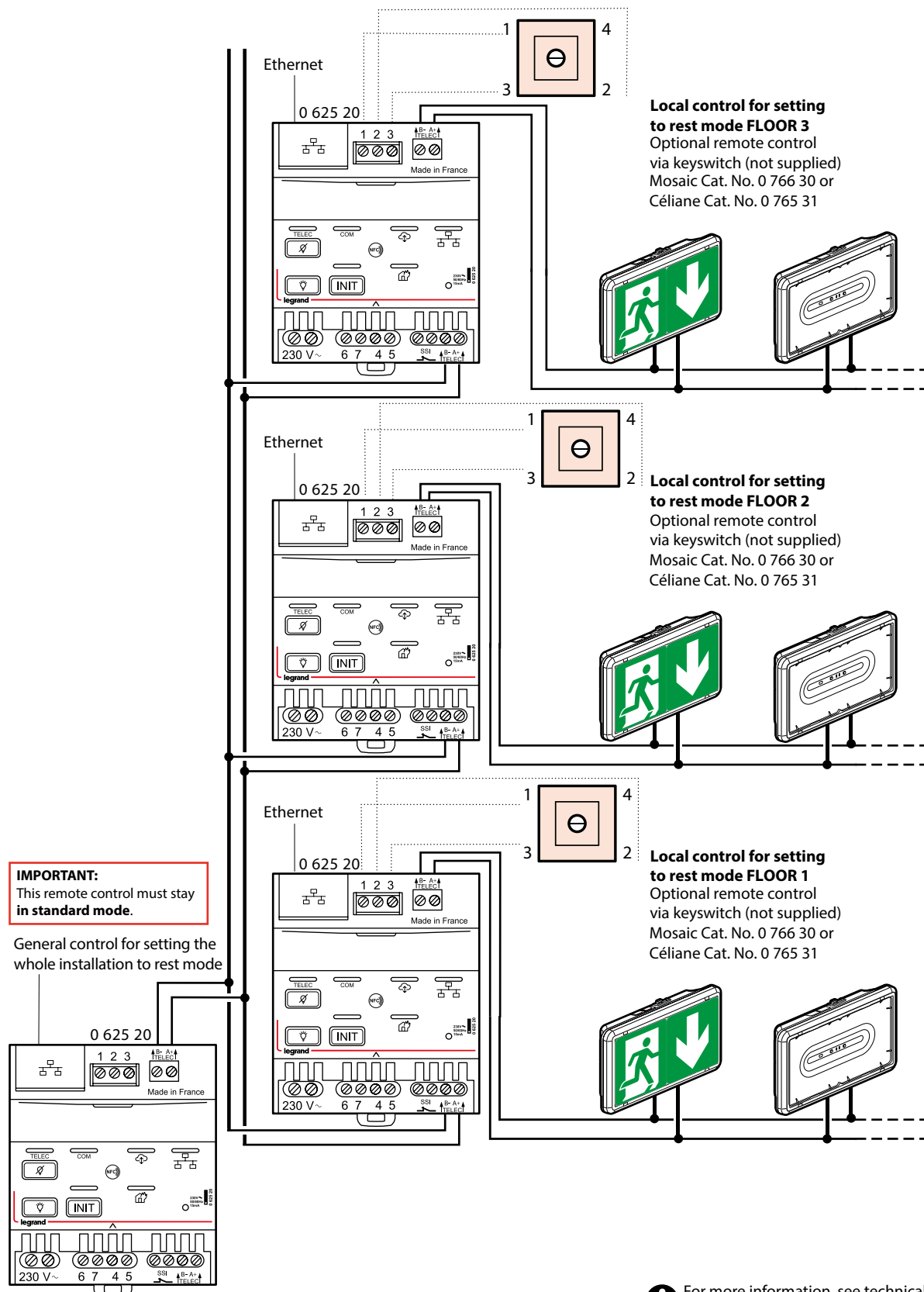

i For more information, see technical data sheet for connected remote control Cat. No. 0 625 20.

4. CONNECTION (continued)

4.2 Remote control for setting to rest mode (continued)

Switching off the lighting and setting units to rest mode remotely (standard mode) with keyswitch (Mosaic Cat. No. 0 766 30 or Céliane Cat. No. 0 675 31 not supplied) or by automation device:

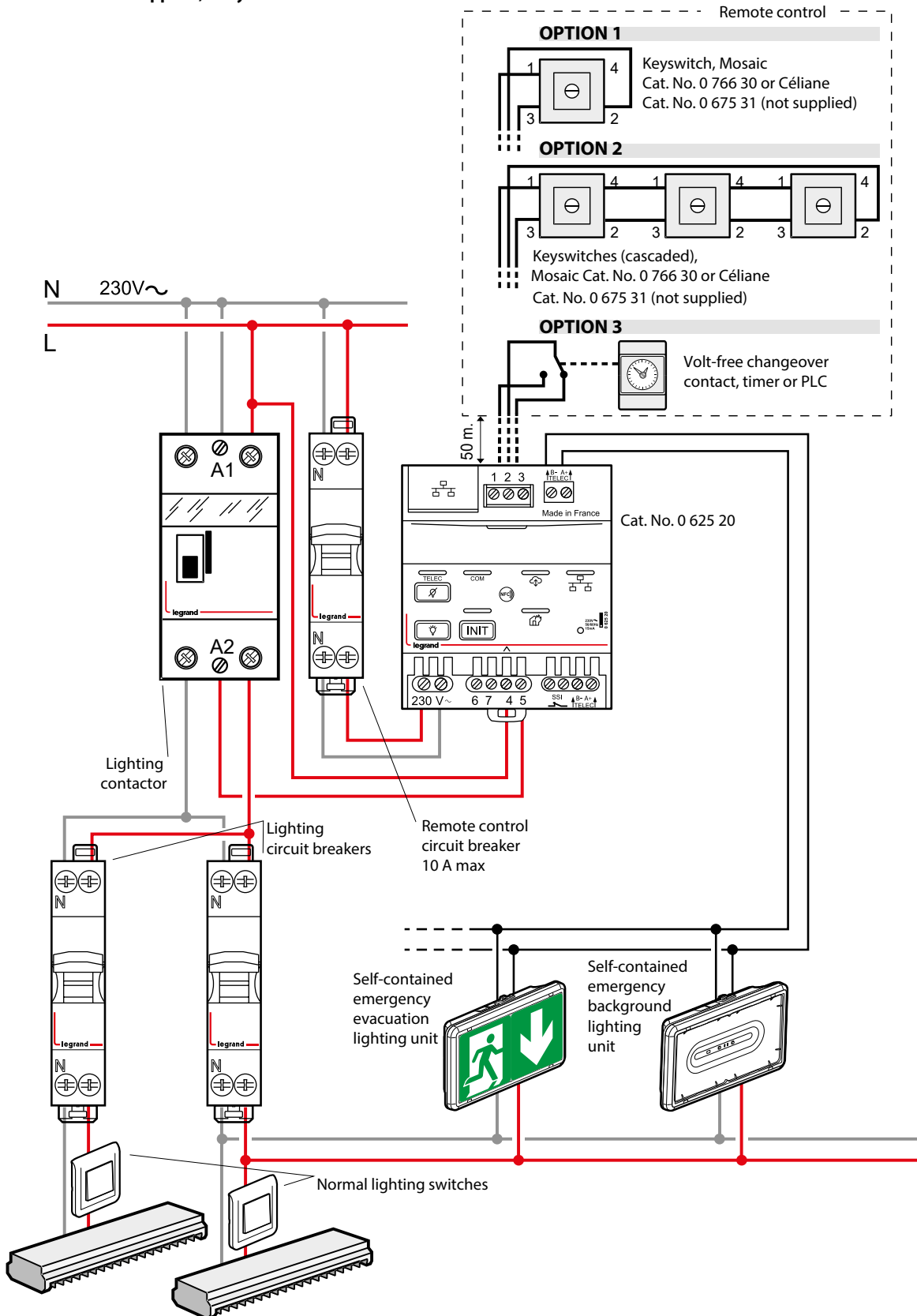

4. CONNECTION (continued)

4.2 Remote control for setting to rest mode (continued)

Setting units to rest mode automatically (standard mode) after the lighting is switched off intentionally:

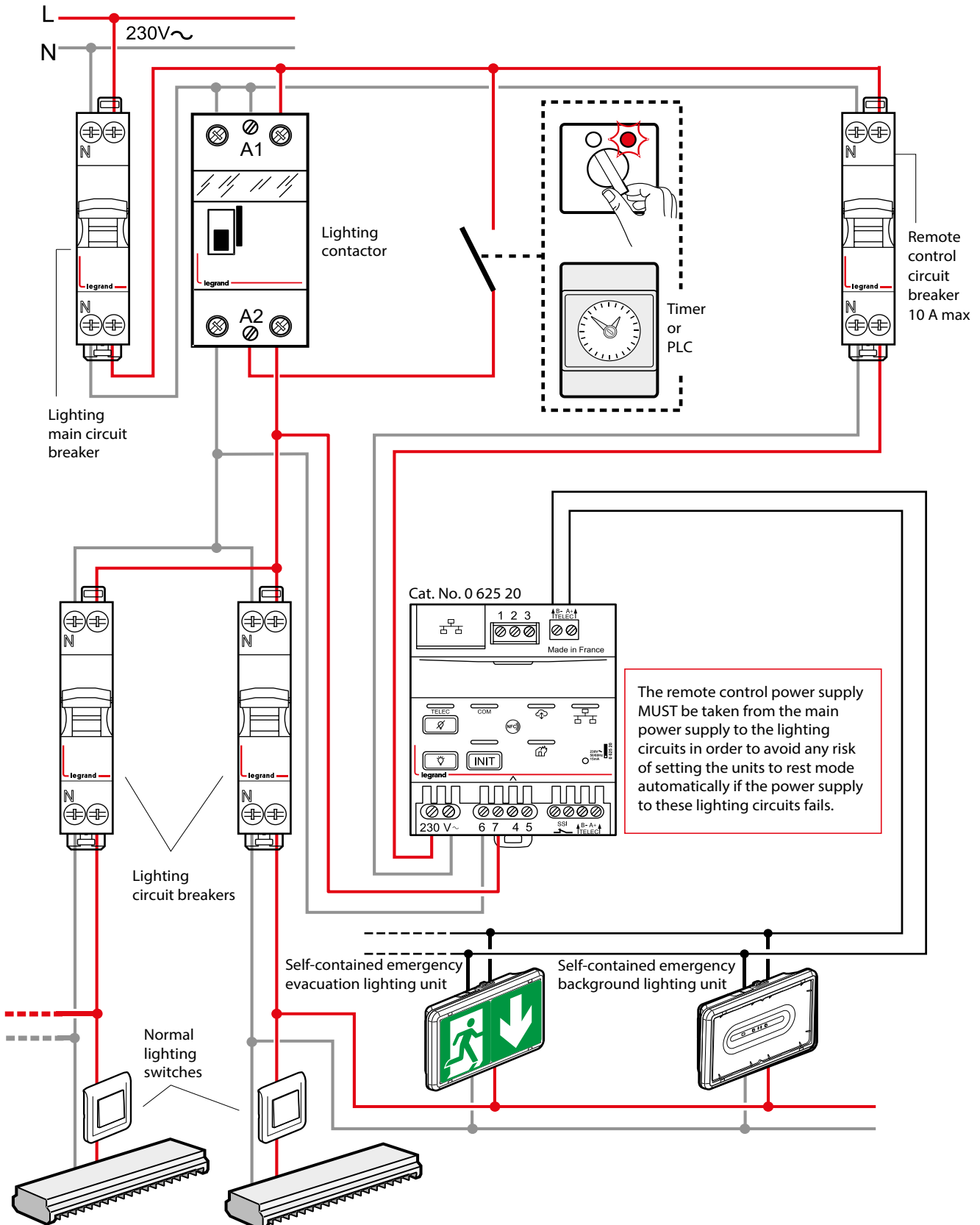

4. CONNECTION (continued)

4.2 Remote control for setting to rest mode (continued)

Operation with [self-contained emergency lighting + home lighting units] and/or reinforced emergency lights and Legrand self-contained emergency lighting units in buildings open to the public that have sleeping accommodation and/or safe waiting areas and operation of self-contained emergency lighting units in increased visibility:

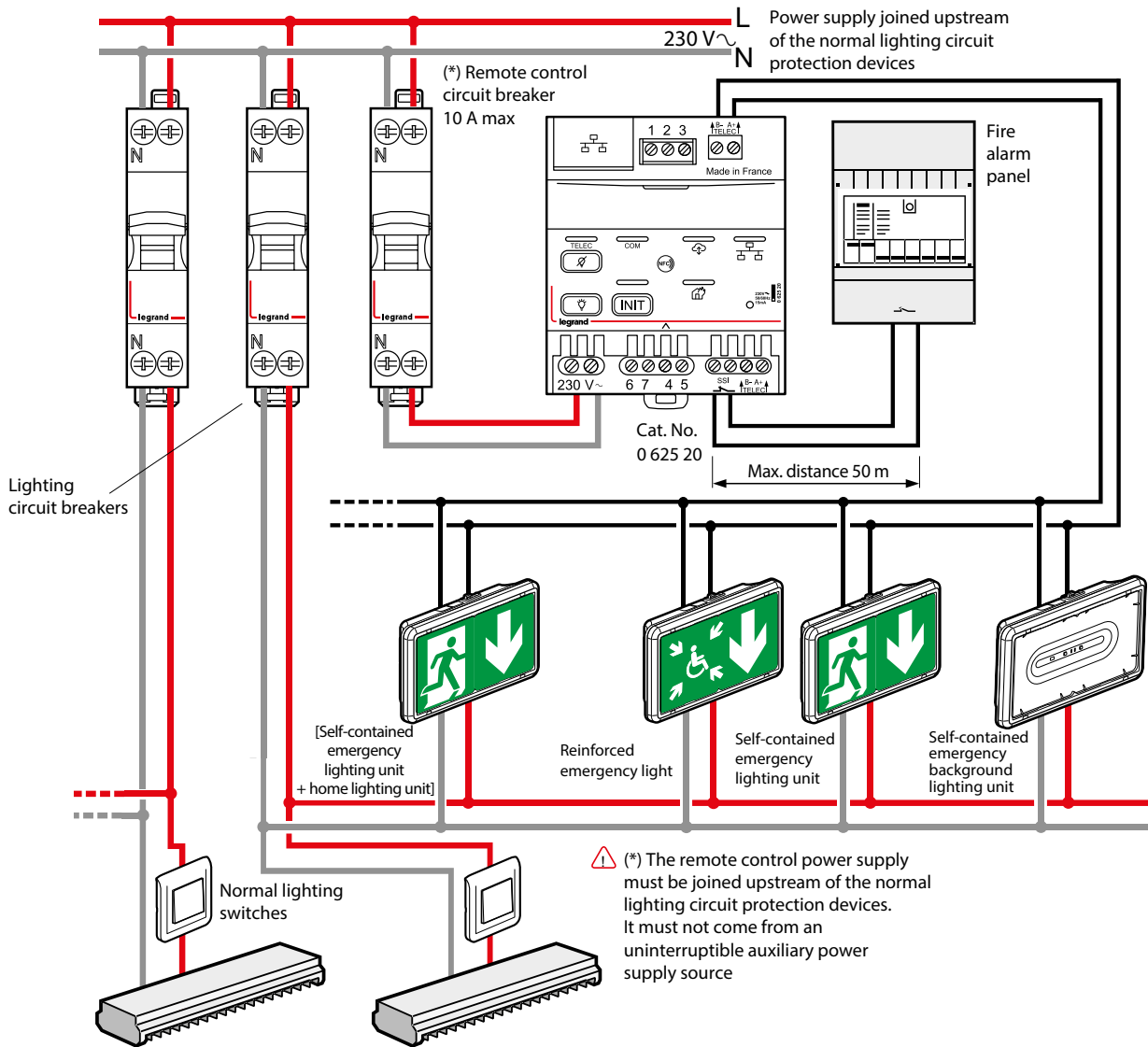

IMPORTANT :

If the fire alarm goes off, remote control unit 0 625 20 memorises the alarm status for one hour to prevent the [self-contained emergency lighting unit + home lighting unit] emergency lighting function accidentally being set to rest mode if there is another general power supply failure.

The red LED indicates detection of contact opening and the fire alarm status (🔴). If the fire alarm is reset within that hour (tests, false alarm, unwanted tripping), deactivate the remote control unit's alarm status by pressing the "off" button (🔴).

Press the "off" button again to switch off the self-contained emergency lighting units.

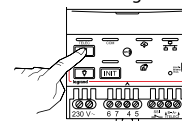

4. CONNECTION (continued)

4.3 Connection for an addressable installation

Installation with general setting to rest state

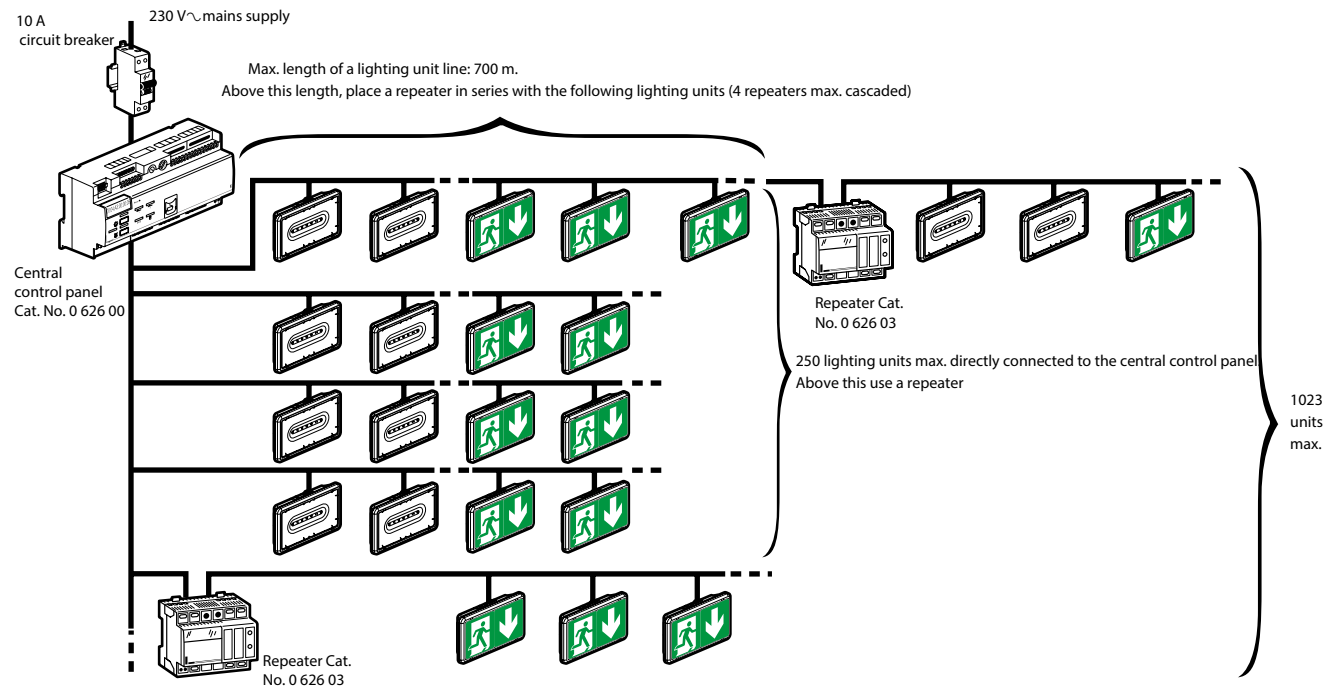

Installation with partial setting to rest state

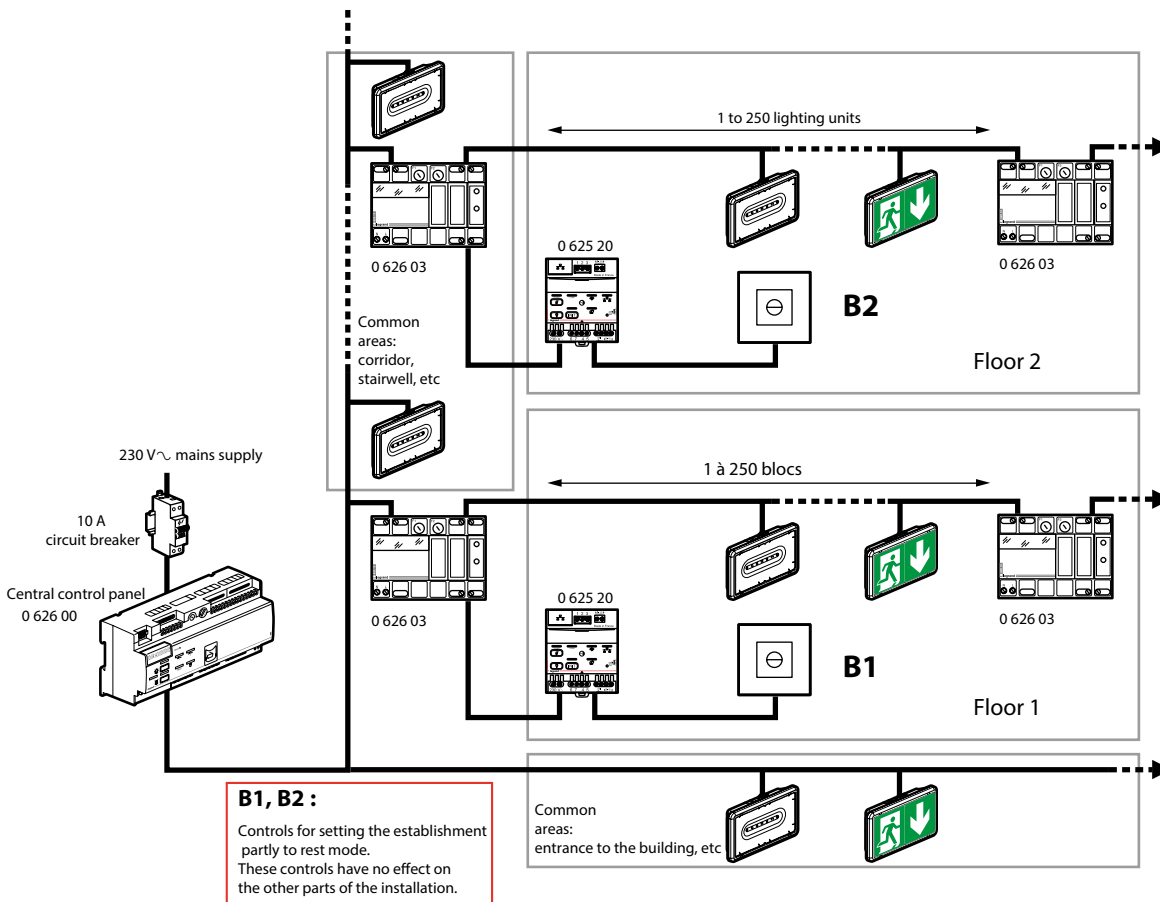

5. MAINTENANCE

■ 5.1 Routine maintenance

• Safety regulations covering public buildings (article EL 18 and EC 13) Routine maintenance of self-contained emergency lighting units is mandatory in public buildings. It can be carried out in accordance with the provisions of standard NF C 71-830. The user must ensure that the lighting units are regularly checked and serviced. The user must ensure that the annual maintenance operations are carried out by a qualified person. After every annual maintenance operation, the qualified person must attach a new maintenance label and fill it in.

Checked by/Company	Signature	Date
Unit no.	legrand	Cat. No. 0 609 00

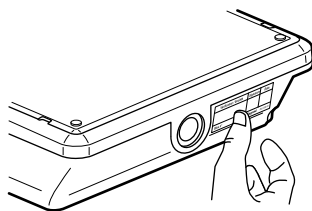

This maintenance label (Cat. No. 0 609 00) must be attached to each lighting unit in a position where it can be seen, and marked with the date on which the unit was commissioned.

• Operation (article EC 14)

The emergency lighting must be set to standby state during operating periods. The emergency lighting must be set to rest mode or off state when the normal lighting installation is switched off intentionally. The use of a hard-wired remote control Cat. No. 0 625 20/21 or 0 039 00/01 and keyswitch in accordance with the corresponding wiring diagram enables the units to be set to rest mode at the same time as the normal lighting is switched off when the premises are not in use.

The user must regularly check the following:

Once a month:

- That the unit switches to operating position if the normal power supply fails, and that all the lights come on (operation must be strictly limited to the time required to carry out the visual check). These checks can be carried out by checking that the green self-test indicator is on on all the units in the installation.
- The effectiveness of the remote command to switch to rest position and the automatic return to standby position when the normal power supply is re-established.

Once every six months:

- At least one hour's standby power. These checks can be carried out by checking that the green self-test indicator is on on all the units in the installation.

■ 5.1 Routine maintenance (suite)

Your installation can be supervised with supervision software Cat. No. 0 626 02 (for more information, see the LE05042XX guide).

List of supervised sites. The site selected in red sees the installation details appear on the right-hand part of the screen

Can provide access to the software from another handset (enter the server settings)



Summary of your installation status by site, showing the number of faults and the breakdown of different states

5. MAINTENANCE (SUITE)

5.2 Replacing the batteries

Ni-MH battery Type 1.2 V - 1.1 Ah AA Cat. No. 0 610 80

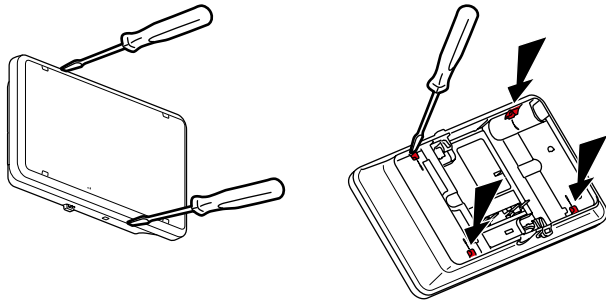

The batteries must be replaced when the self-contained unit can no longer stay on for its rated operating time.

Important: The product must be in rest mode before dismantling.

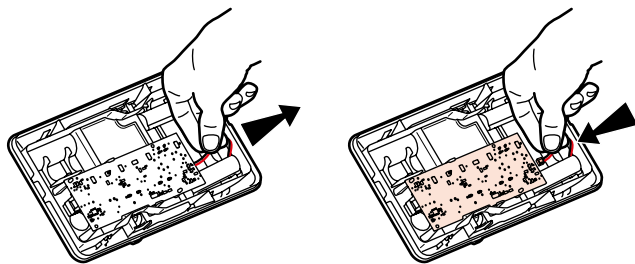

Legrand distribution partners take back used lighting units and batteries.

When the batteries have been changed, replace the maintenance label, marking on it the date on which the unit was returned to service.

6. COMPLIANCE AND APPROVALS

NF C 71 805: French standard "Performance of self-contained emergency evacuation lighting units for residential buildings subject to regulation. Compliance with this standard is mandatory when installing self-contained emergency home lighting units in France.

NF EN 62 034: Automatic test systems for battery-powered emergency lighting.

NF C 71 820: French standard "Automatic test system for emergency lighting equipment".

NF EN 60 598-2-22: European standard "Luminaires: specific rules. Luminaires for emergency lighting".

NF EN 60 598-1: European standard "Luminaires".

UTE C 71 806: Rules applicable to the use of NiMH batteries in self-contained emergency lighting units
The "NF AEAS performance SATI" mark certifies compliance with these standards.

NF 413 NF ENVIRONMENT Emergency lighting units.

The "NF Environment" mark certifies compliance with this standard.

NF EN 50172: European standard "Emergency lighting systems".

NF EN 1838: European standard "Lighting applications – Emergency lighting".

Directives

- LV directive 2014/35/EU of 26/02/2014 and 2011/65/EU of 08/06/2011 amended by 2015/863 of 31/03/2015 (ROHS 2)

- EMC directive 2014/30/EU of 26/02/2014

7. EQUIPMENT AND ACCESSORIES

7.1 Flush-mounting box Cat. No. 0 626 94

For fixing units in false ceilings:

- Fix using claws on solid load-bearing support, plaster, plasterboard, wood, etc.
- Fix using threaded rod, hooks or cables for flush mounting in suspended ceilings.
- Enables maintenance operations in flush-mounted position.
- Fix in wall or ceiling (plasterboard) or wood.

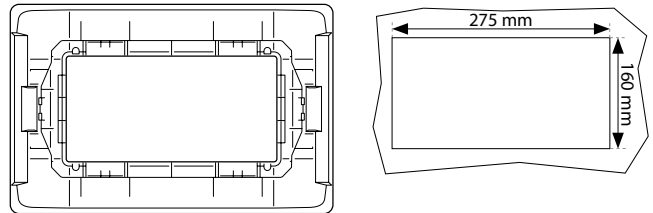

New installation

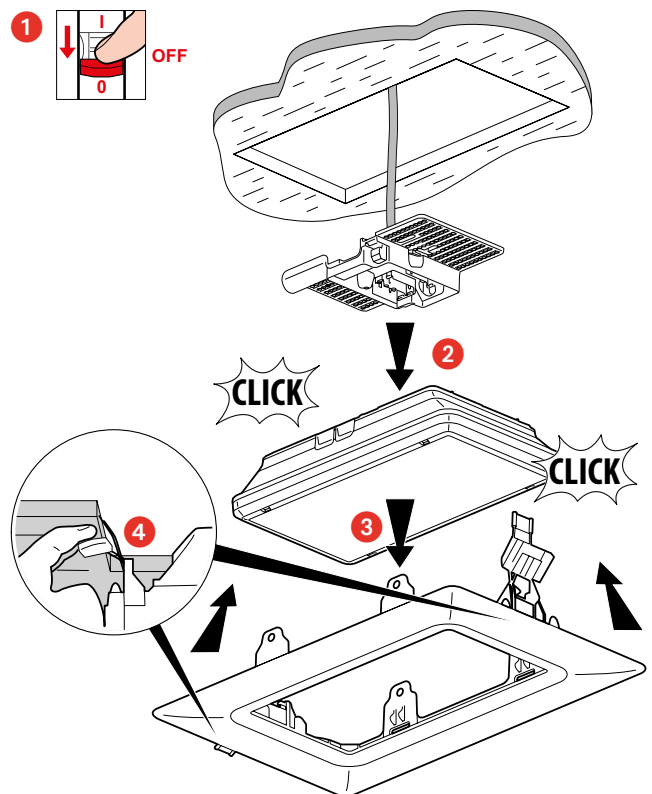

- 1 Switch the installation off
- 2 Wire up the plate and fix it on the self-contained emergency lighting unit
- 3 Clip the self-contained emergency lighting unit into the box
- 4 Mount the box in the ceiling, holding the springs with both hands

7. EQUIPMENT AND ACCESSORIES (continued)

■ 7.2 Suspension kit Cat. No. 0 626 77

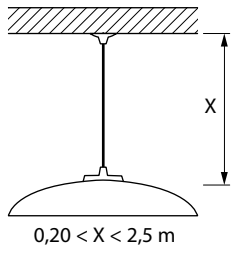

Tube Ø: 20 mm
 MRL 5557 020 - Cat. No. 09720
 zinc-plated steel
 MRL 5557 020 - Cat. No. 09920
 stainless steel

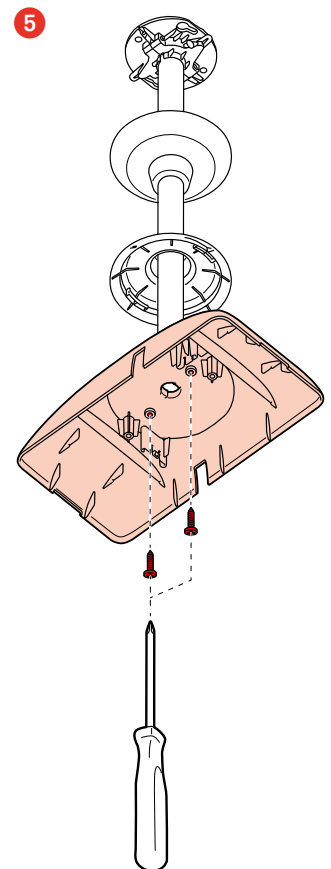
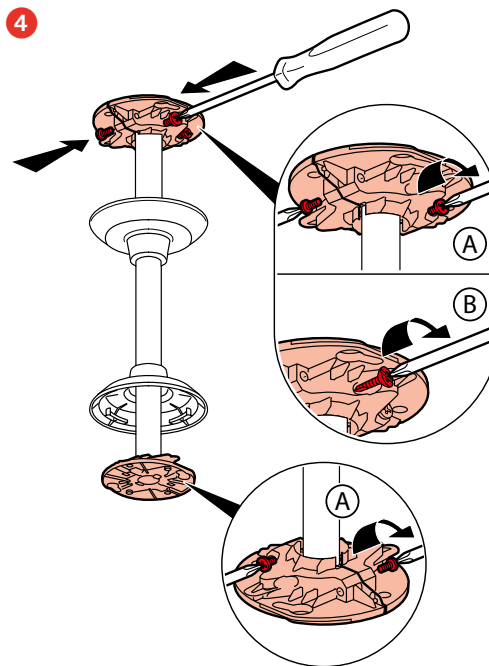
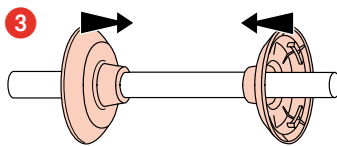
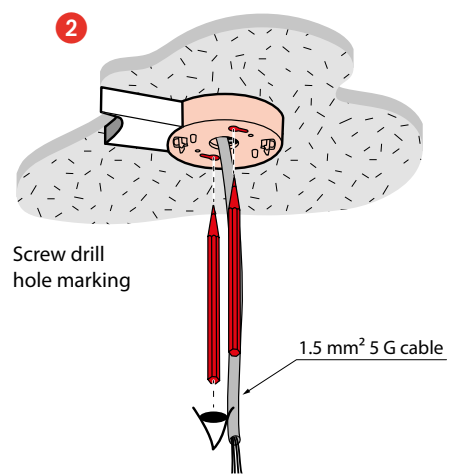
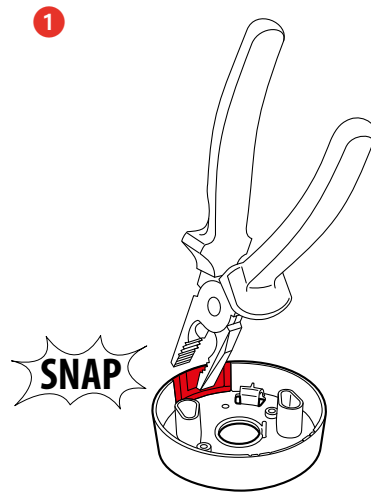

7. EQUIPMENT AND ACCESSORIES (continued)

■ 7.2 Suspension kit Cat. No. 0 626 77 (continued)

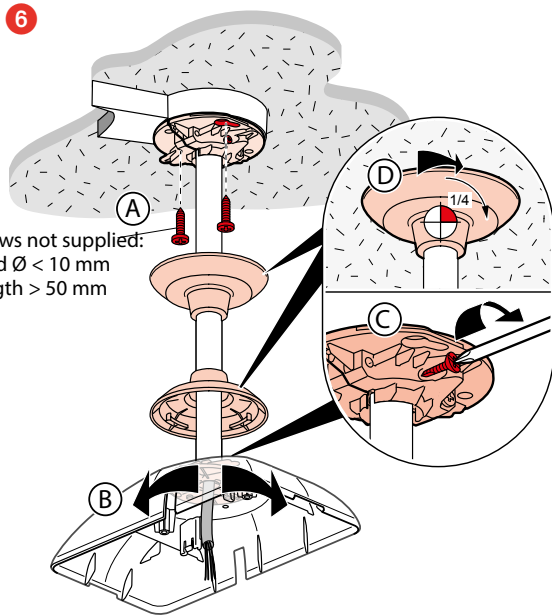

Screws not supplied:
Head Ø < 10 mm
Length > 50 mm

OR

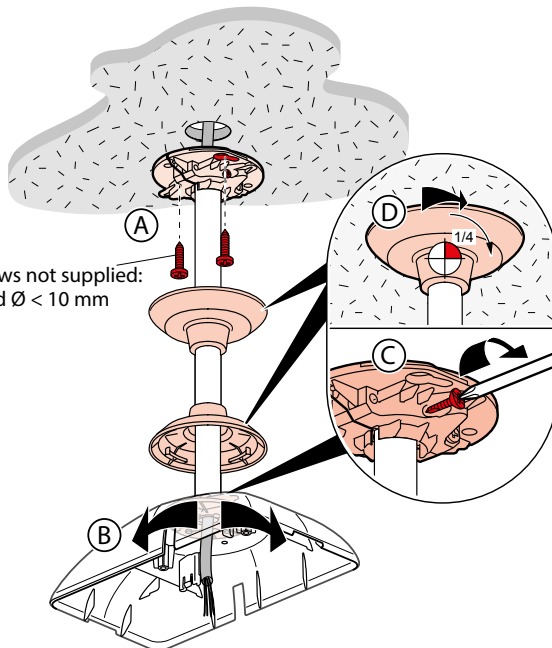

Screws not supplied:
Head Ø < 10 mm

■ 7.2 Suspension kit Cat. No. 0 626 77 (continued)

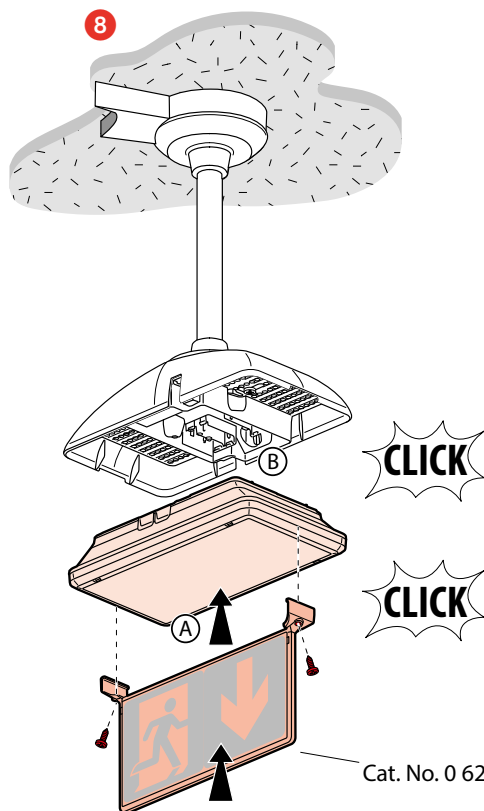
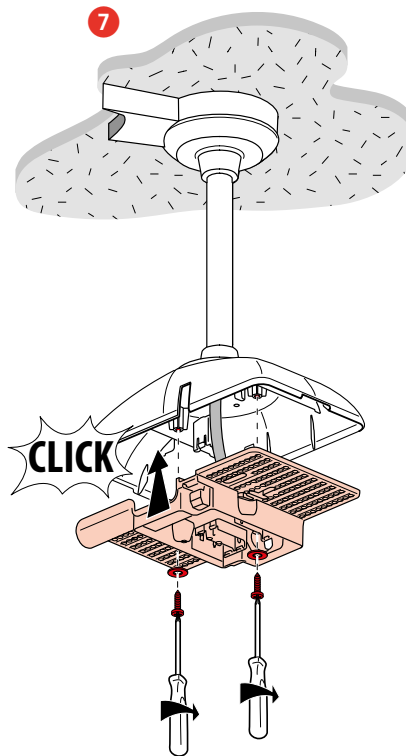

7. EQUIPMENT AND ACCESSORIES (continued)

■ 7.3 Grilles

7.3.1 Standard protective grille Cat. No. 0 626 90

Impact resistance: IK 10 - 20 joules

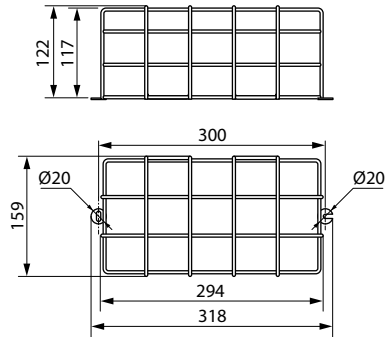

7.3.2 Vandal-resistant protective grille Cat. No. 0 626 92

Impact resistance: IK 20 - 50 joules

Wall-mounting base on metal frame held in place by 4 metal bolts. Locked with vandal-proof screws, requiring tool Cat. No. 0 919 45 (not supplied).

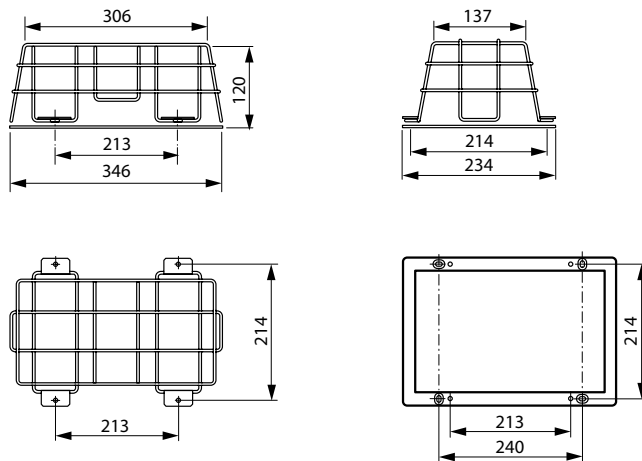

• Screw tool Cat. No. 0 609 10

For fitting vandal-proof screws in grille Cat. No. 0 626 92.

