

PHILIPS

Maxos Fusion

LL500Z 3C

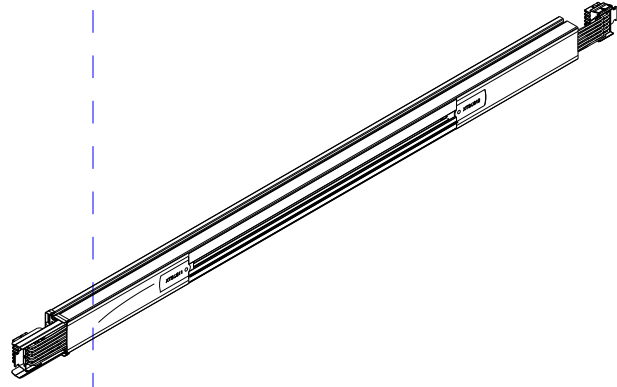

50Hz
60Hz

220V
240V



IP20

IK02



	WH	A(mm)	B(mm)	C(mm)	
LL500Z 3C	SI	43	1339	65	3.2
	BK				

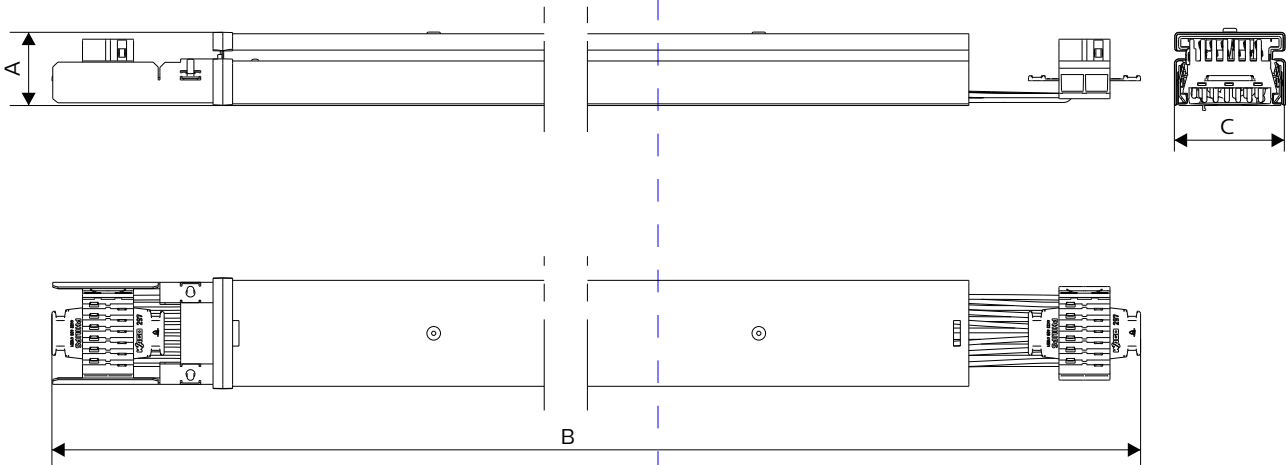

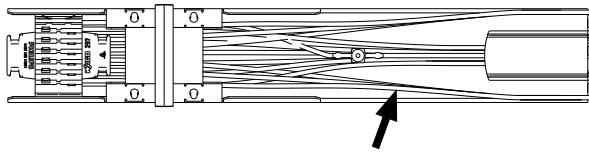

Solid wire 2.5 mm²

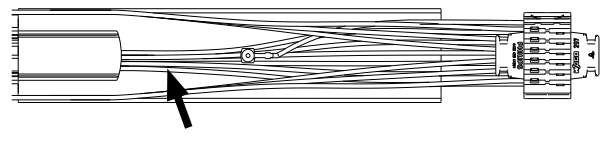

Stranded Wire 1.5 mm²

1



Maximum weight load 5 kg

2



Additional Bracket
in the middle of
LL500Z 3C

Distances for ceiling mounted fixation

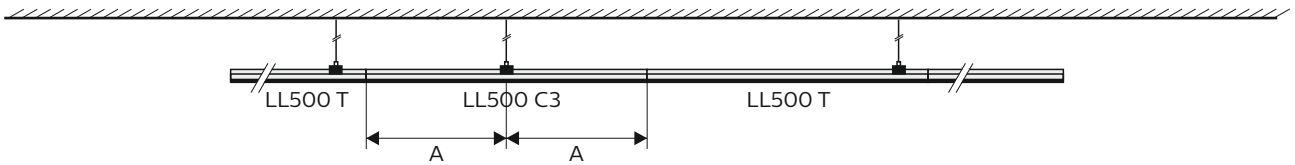

Additional Bracket
in the middle of
LL500Z 3C

Distances for surface mounted fixation

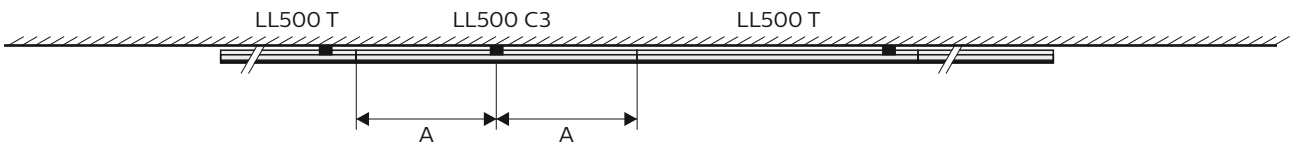

3

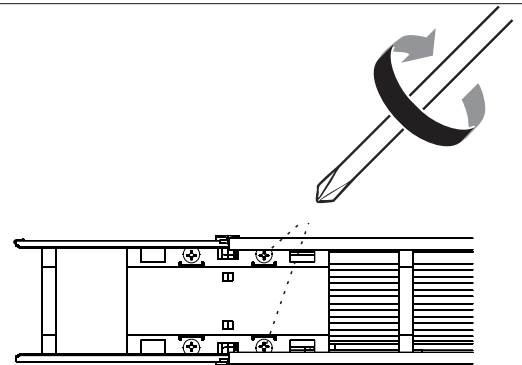
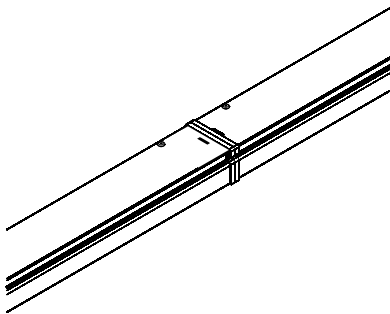

4